

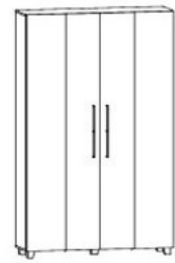

























# TODD 160

L-135 H-216 D-42



<b>x 14</b>  AKC00120	<b>x 14</b>  AKC00004	<b>x 12</b>  AKC00029	<b>x 12</b>  AKC00151	<b>x 12</b>  AKC00004	<b>x 8</b>  ZAW00017	   120 min
<b>x 6</b>  ZAW00016	<b>x 6</b>  AKC00007	<b>x 1</b>  AKC00036	<b>x 6</b>  AKC00008	<b>x 3</b>  AKC00107	<b>x 7</b>  AKC00150	
<b>x 63</b>  3x16 AKC00026	<b>x 23</b>  3.5x16 AKC00026	<b>x 6</b>  4x25 AKC00026	<b>x 6</b>  AKC00085	<b>x 100</b>  AKC00018	<b>x 1</b>  AKC00017	<b>x 4</b> L-1500 mm <b>x 1</b> L-350 mm  TAP00187
<b>x 5</b>  NOG00015	<b>x 2</b>  UCH00017	<b>x 2</b> L-795 mm  AKC00032				

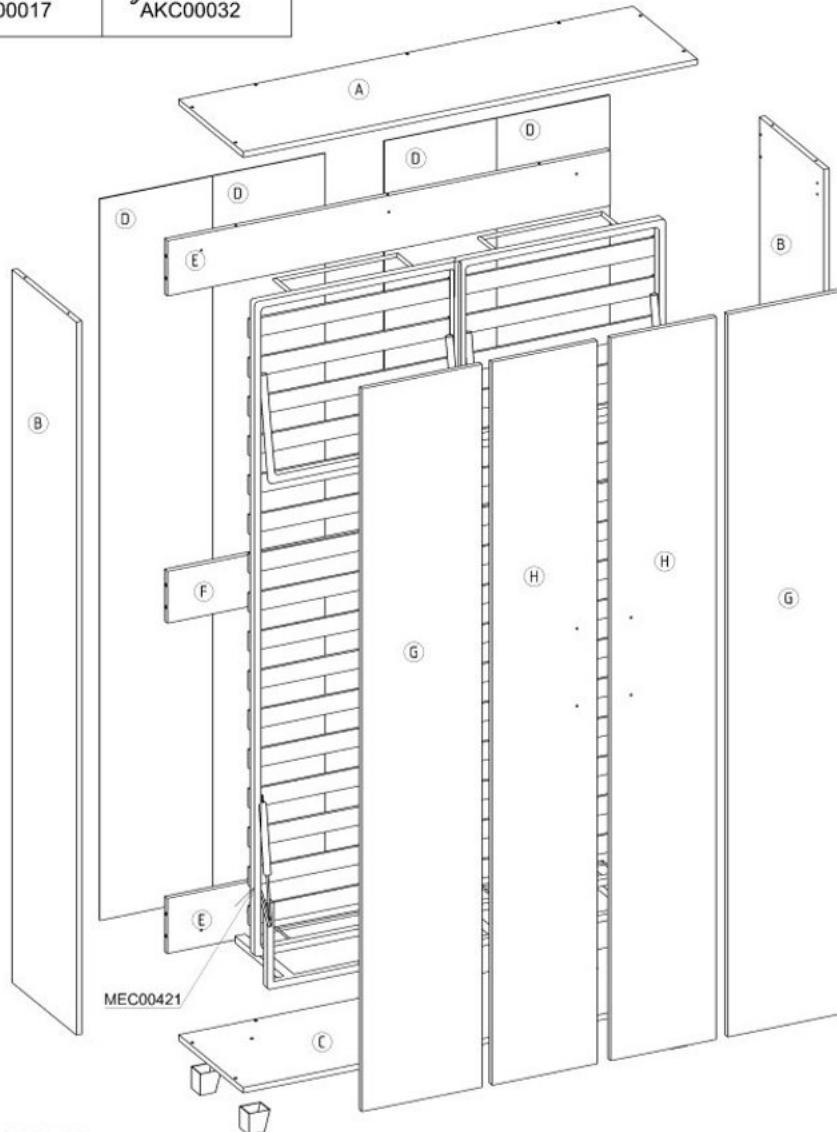

1

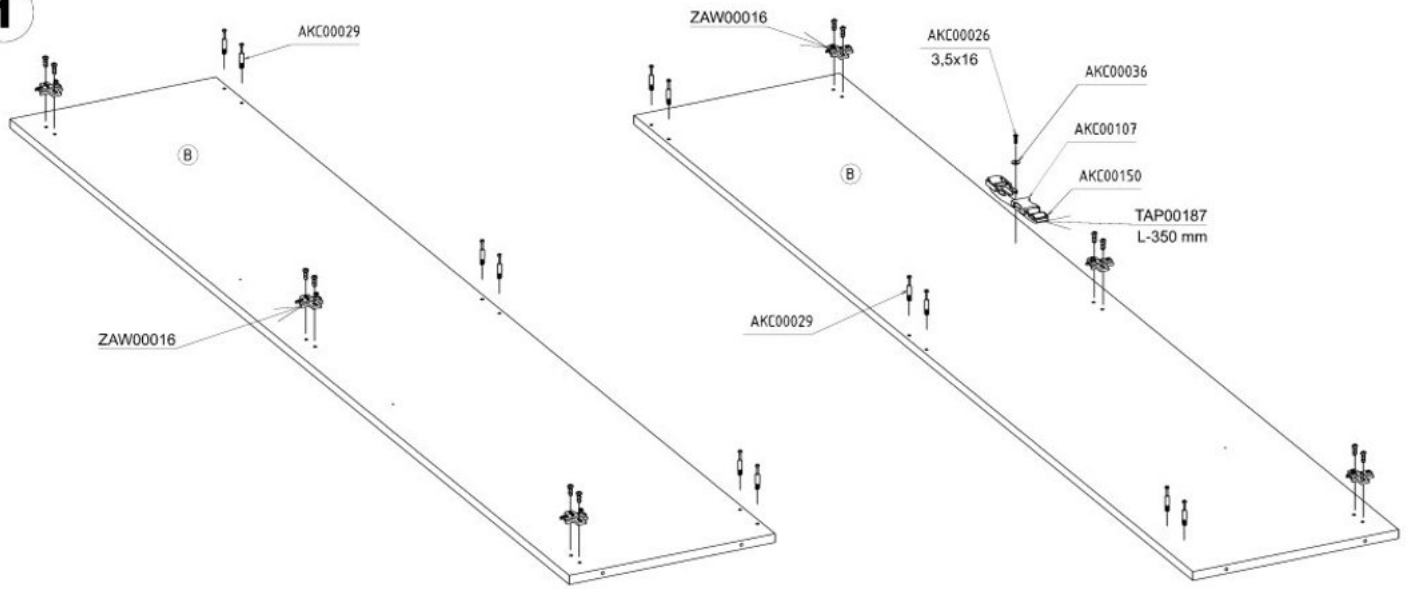

2

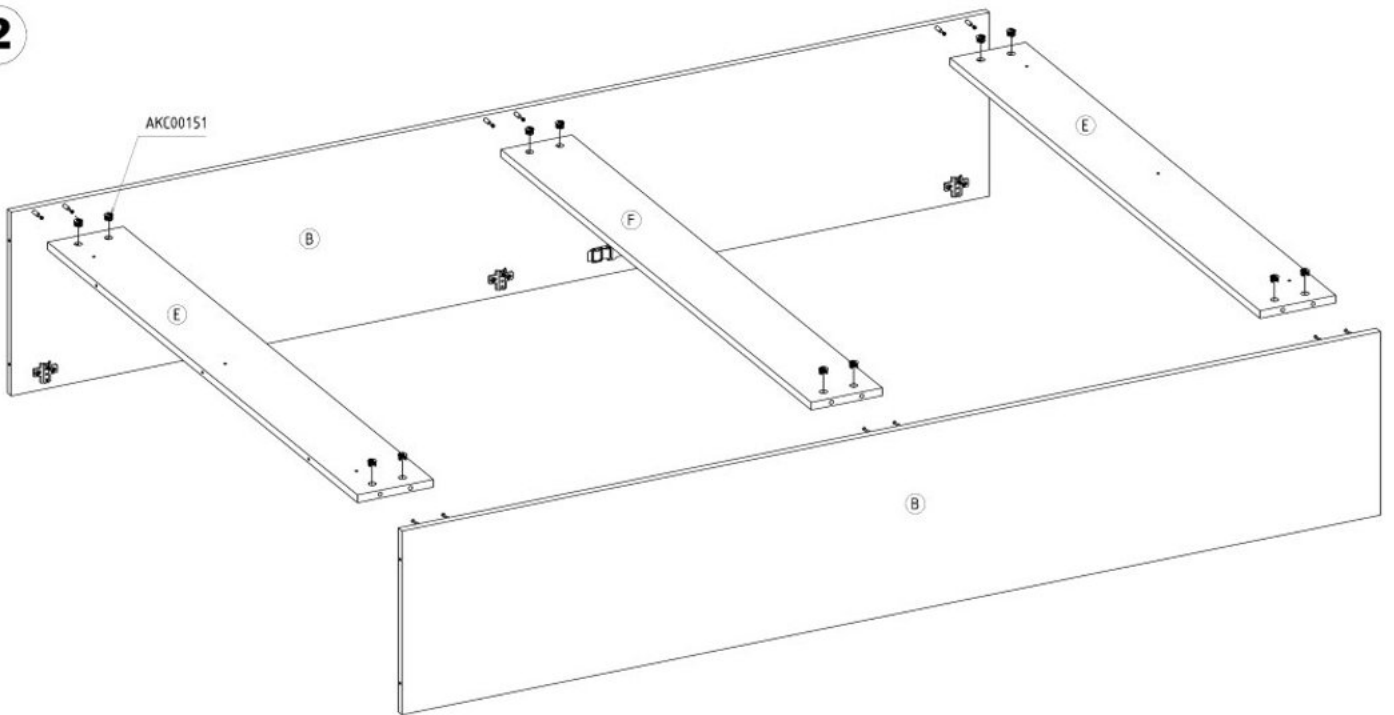

3

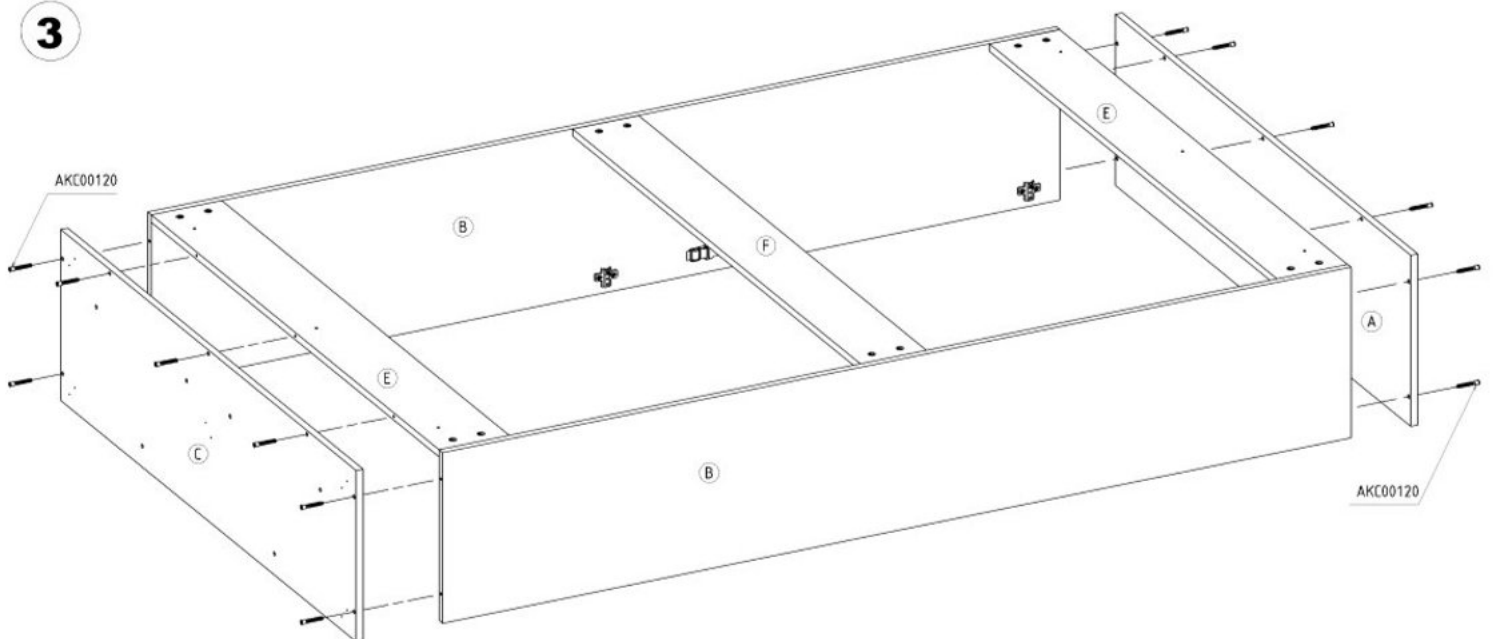

4

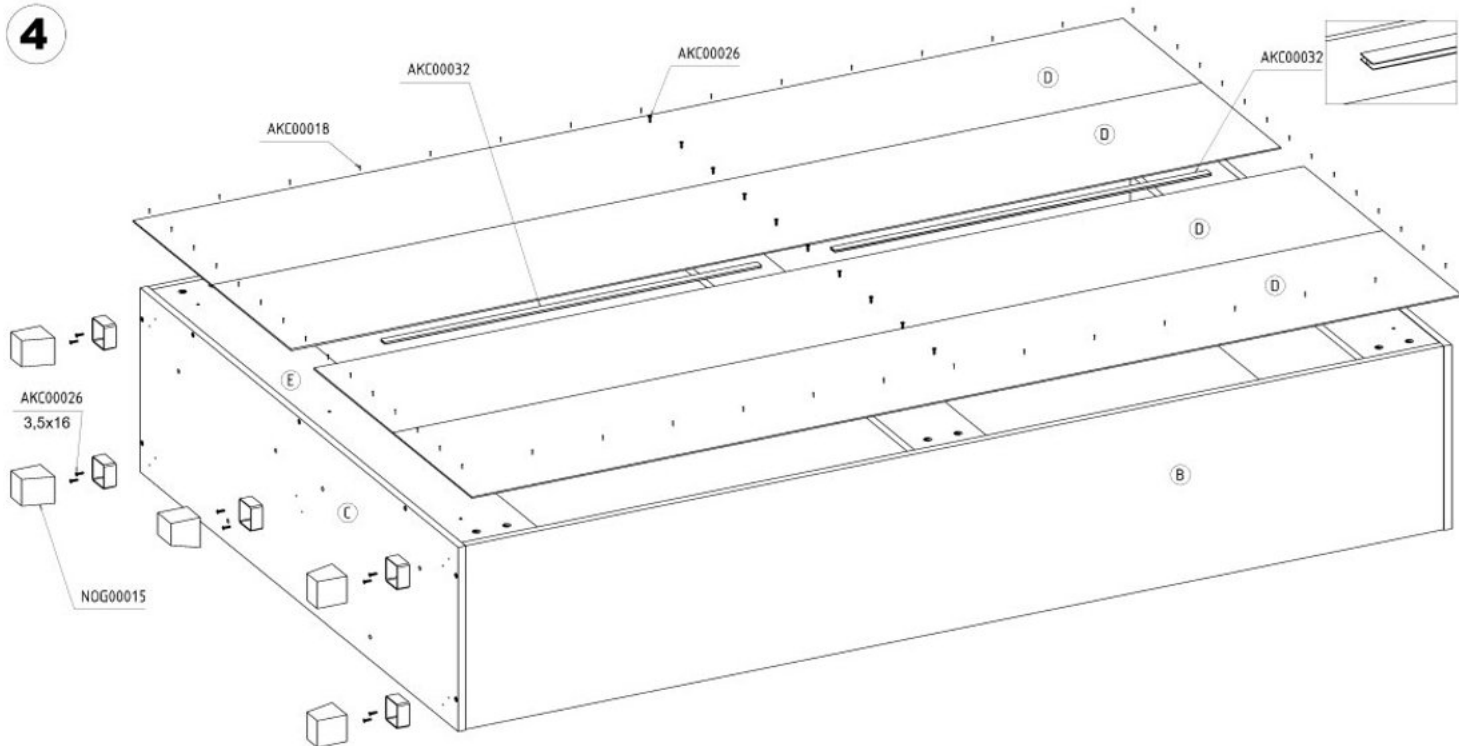

5

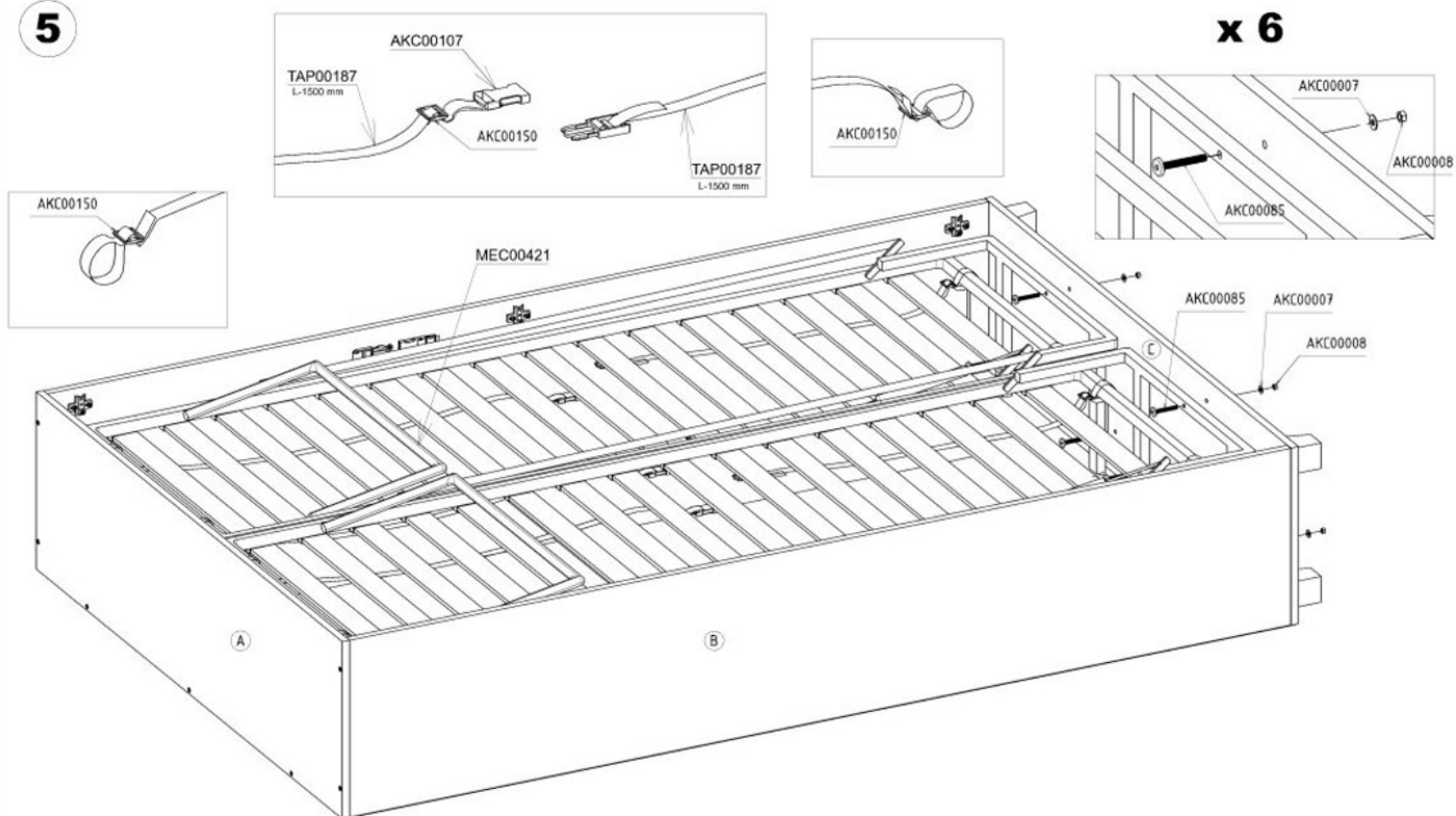

6

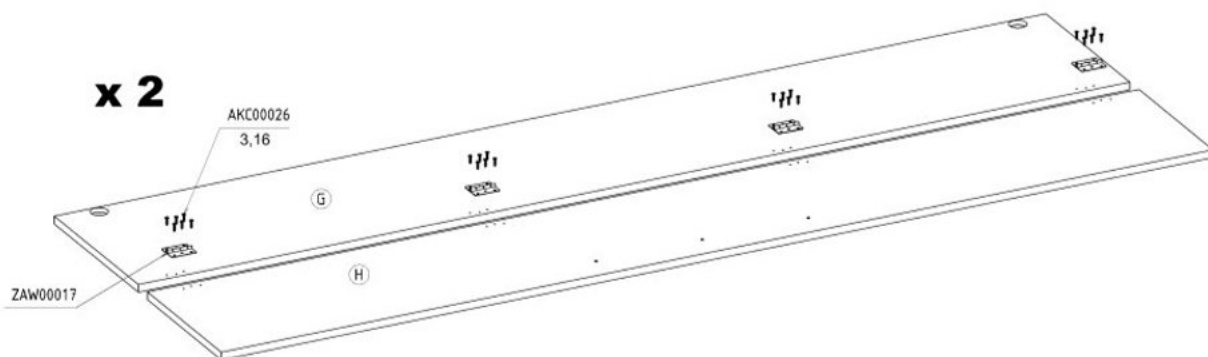

7

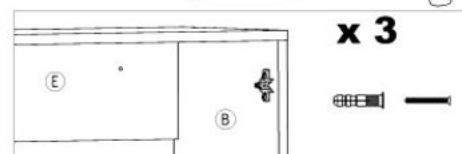
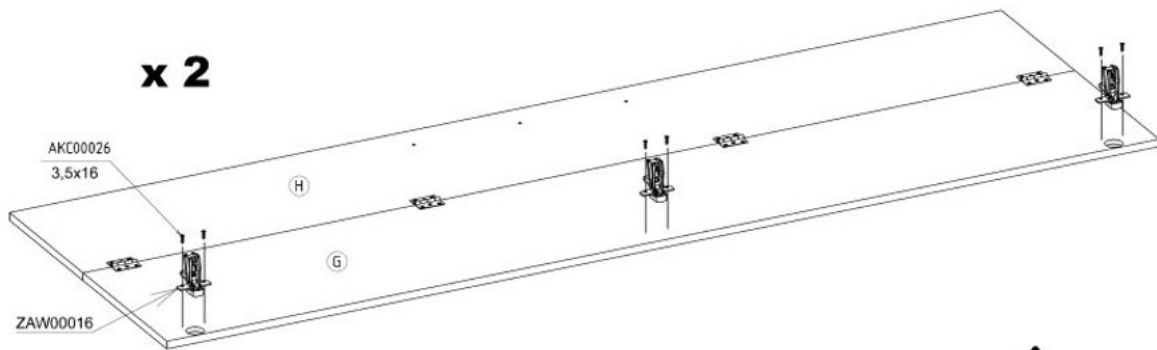

8

