

40 DK-2100 2F

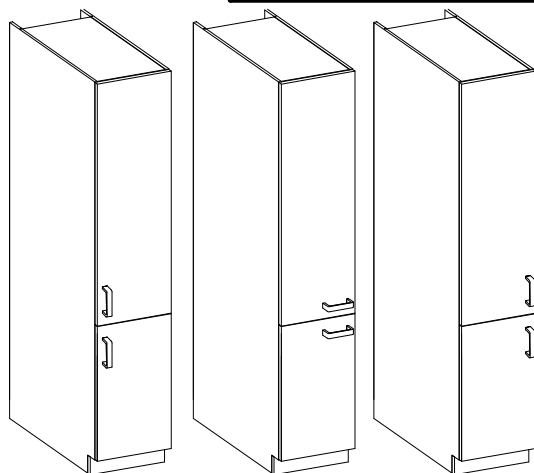

max.
5kg

- KUH.30009
- KUH.40025
- KUH.40026

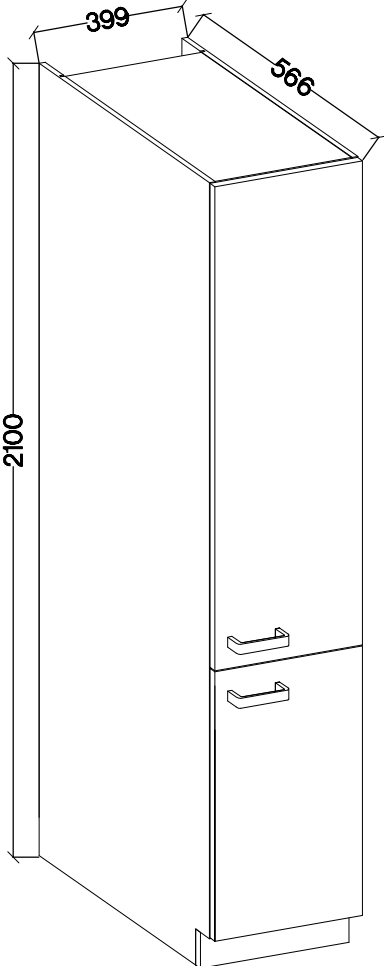
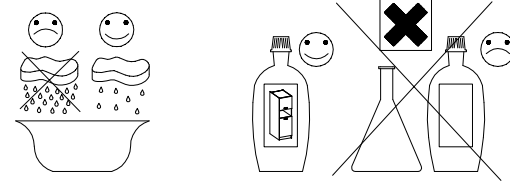
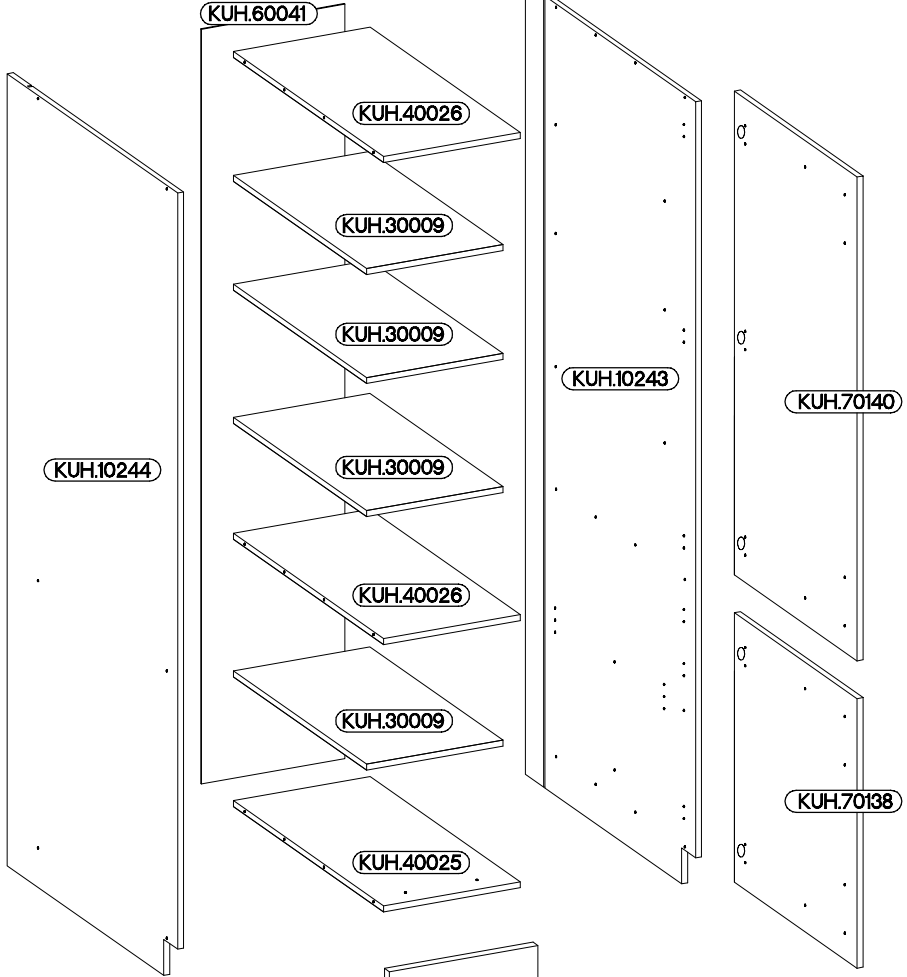
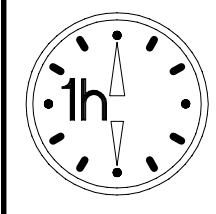



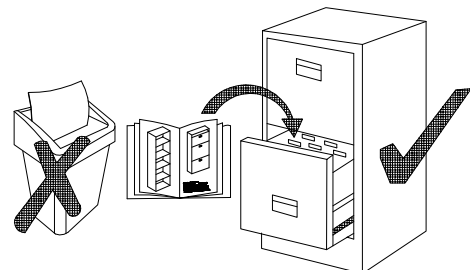

(KUH.90039)

+8x30mm A	6,4 x 50mm B			6.5x48x16 F2	+35/0mm HG	+5/19mm J
12	12	12	2	4	5	16
L25		+4.0x45mm P4	+3.5x13mm P5	+3.0x20mm P7	S23	M4x22mm U
1	1	2	12	10-15	2	4



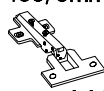

1

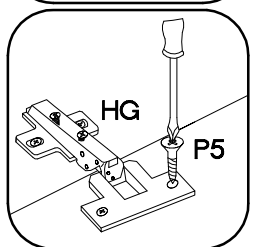
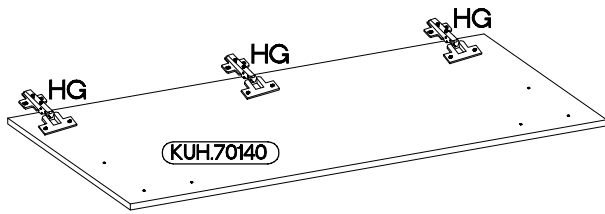
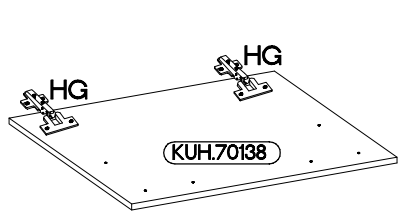
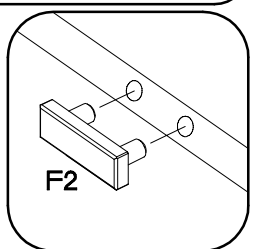
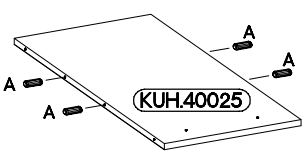
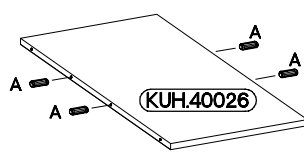
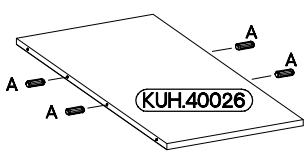
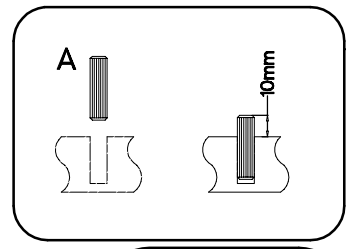
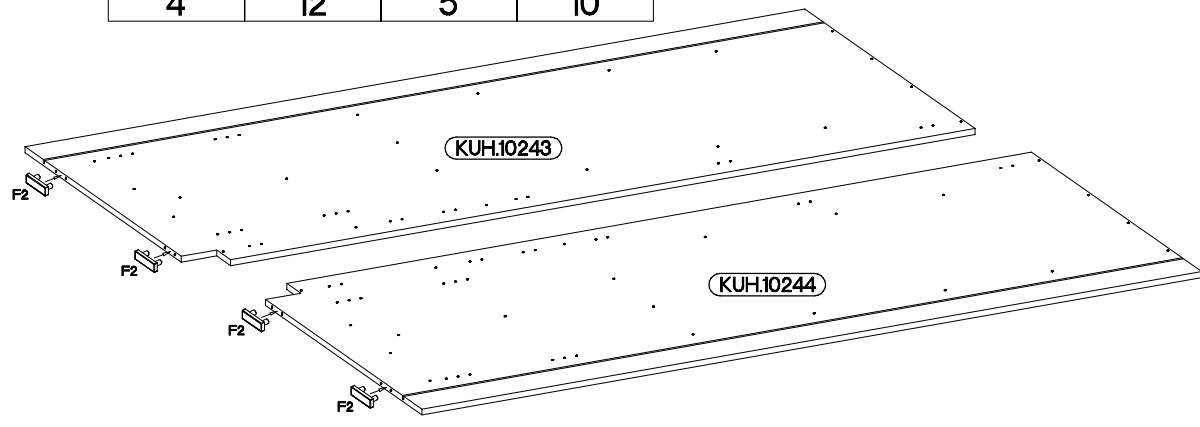
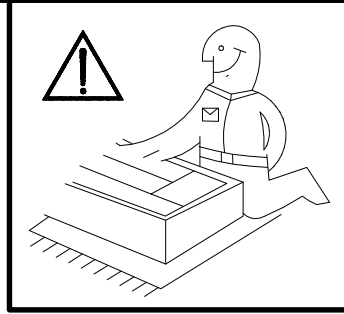
6.5x48x16	+8x30mm	+35/0mm	+3.5x13mm
			
F2	A	HG	P5
4	12	5	10

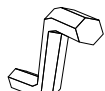

2

6,4 x 50mm			
B	O	E1	
6	1	6	

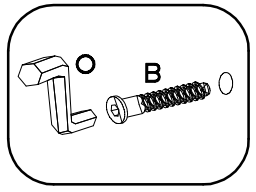
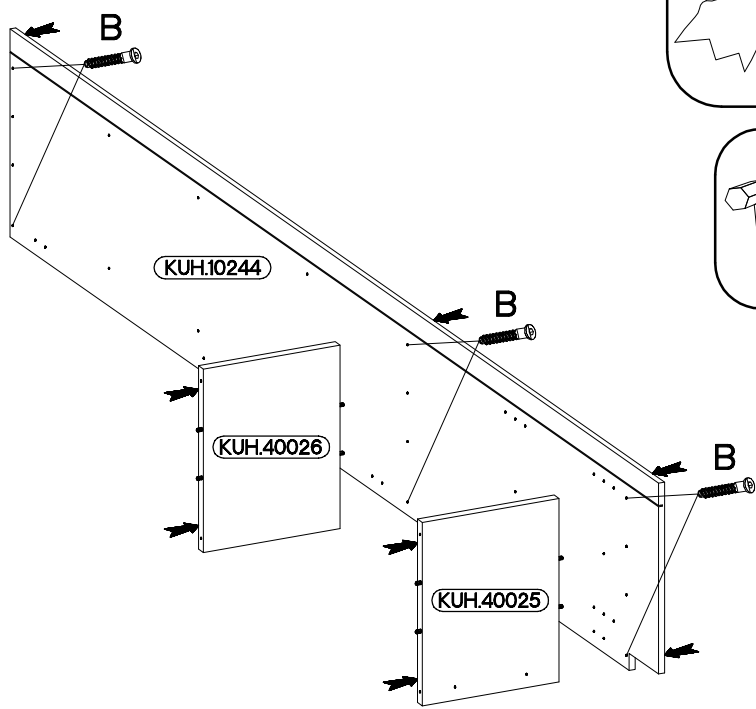
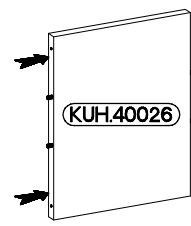
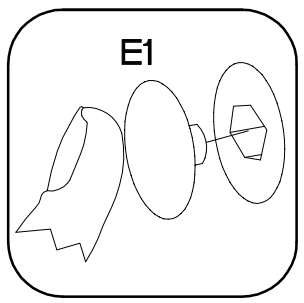

3

6,4 x 50mm

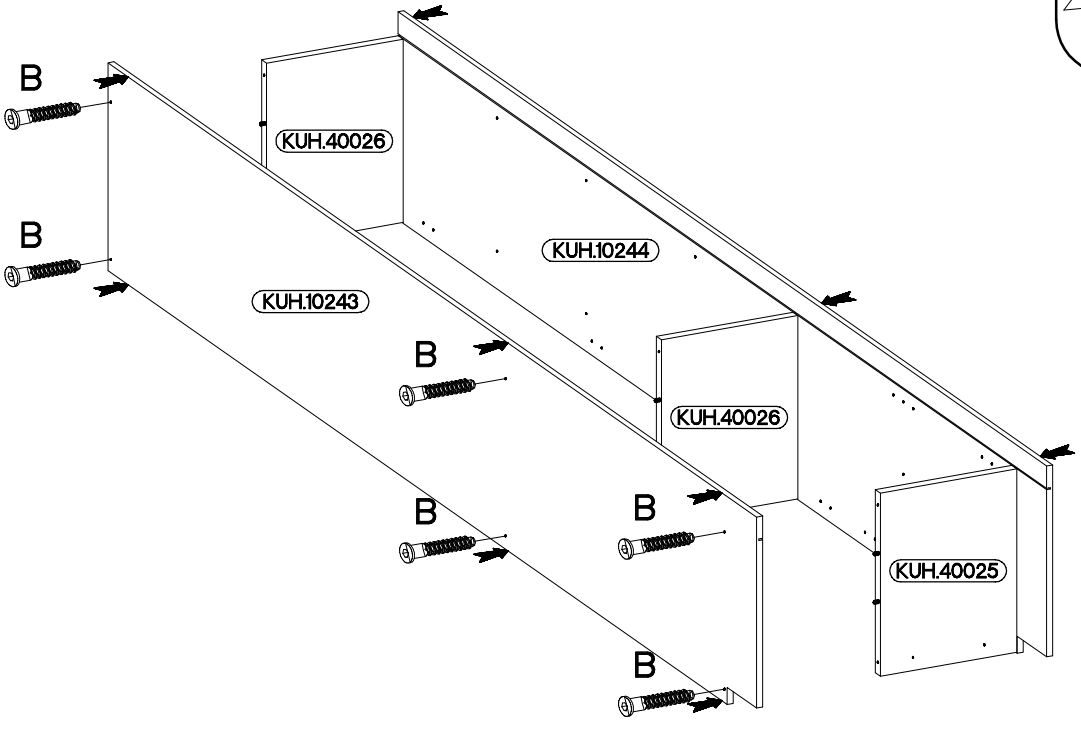
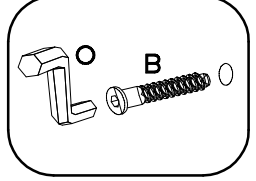
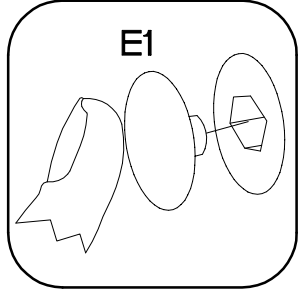
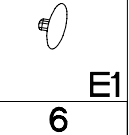
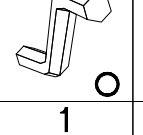
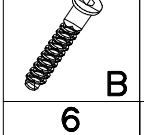

4

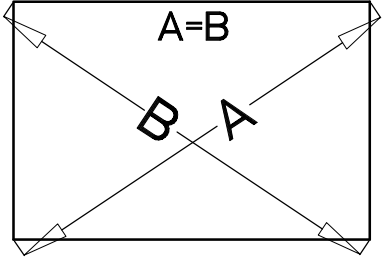
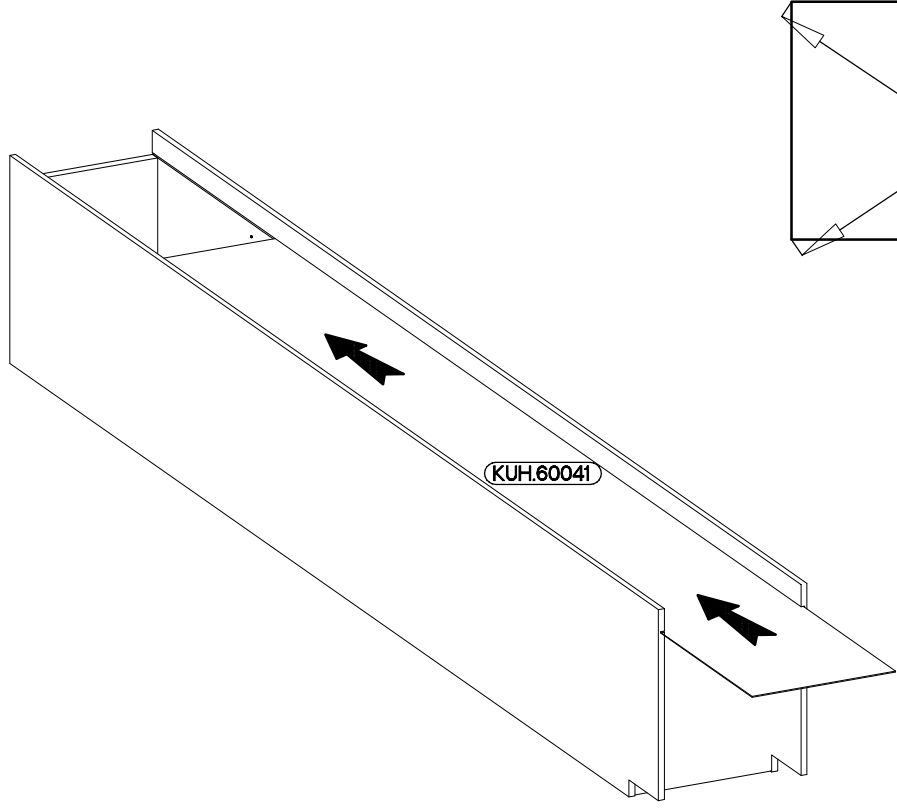

5

±3.0x20mm



P7

10-15

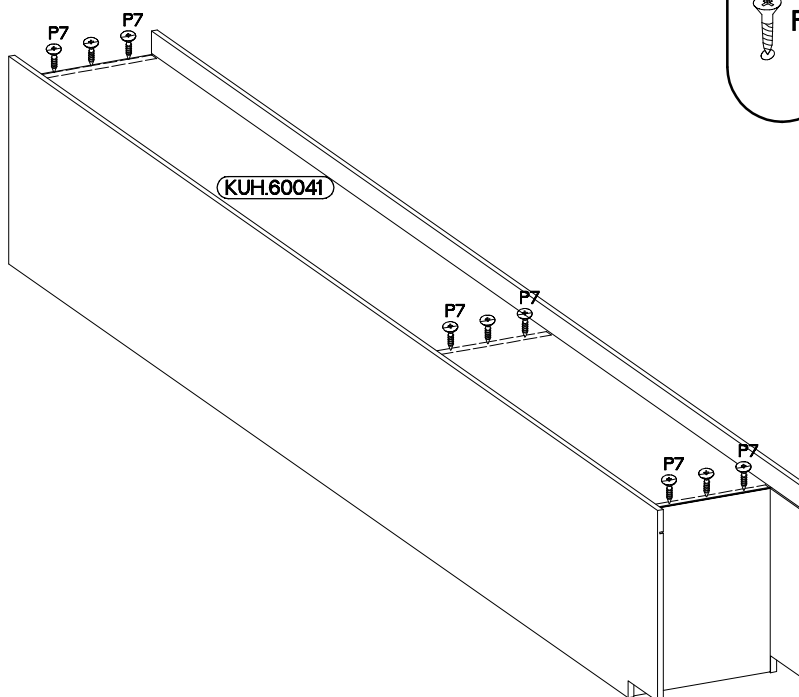
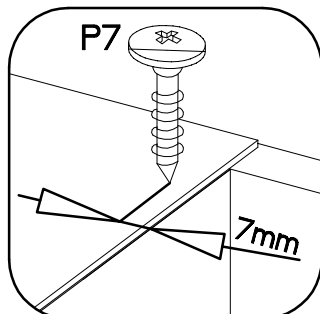
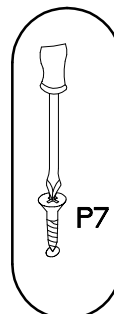

6

±4.0x45mm



P4

2



E9

2

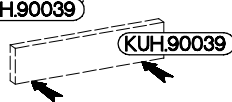
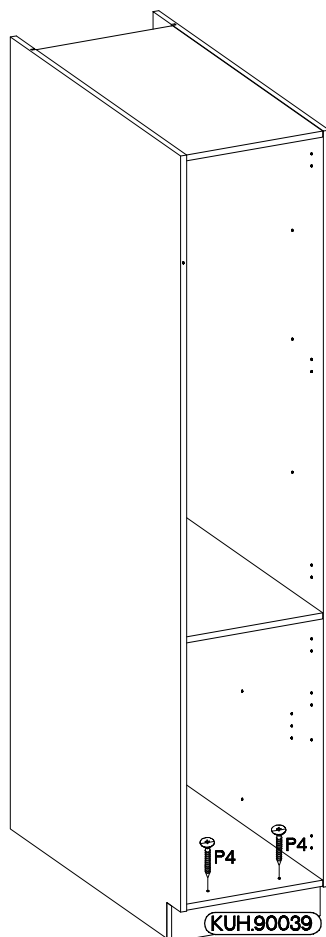
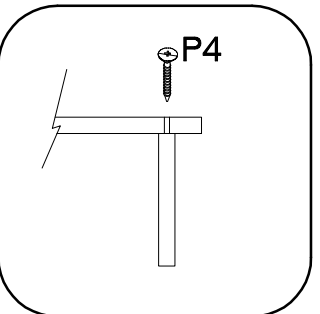
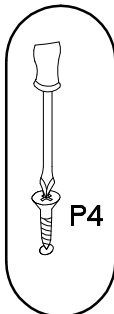

7

±5/19mm



J

16

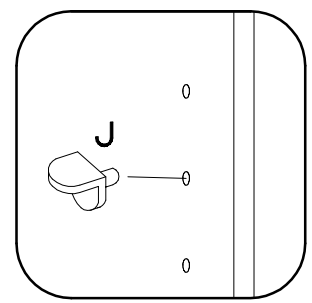
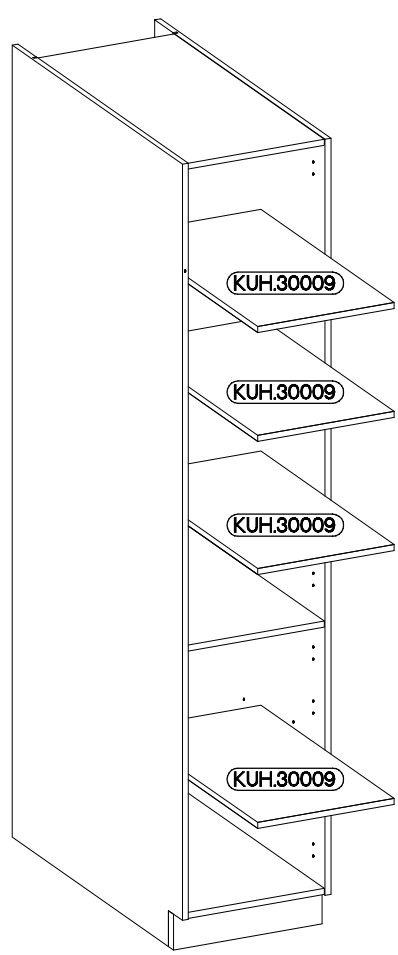

8

±3.5x13mm

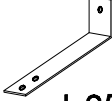

L25

1



P5

2

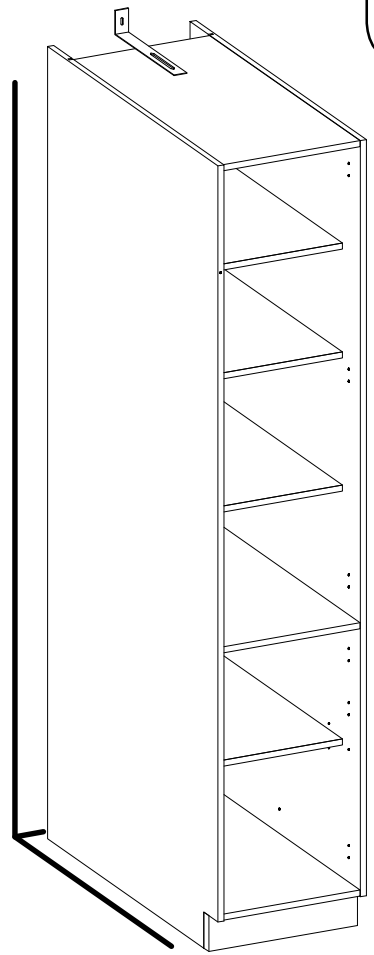

1.

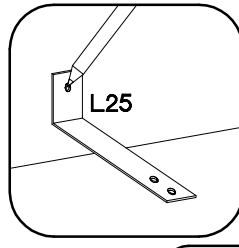

2.

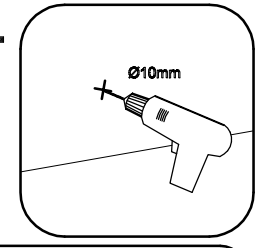

3.

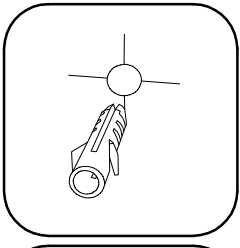

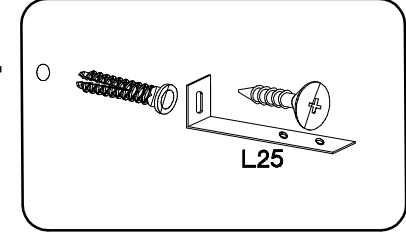

4.

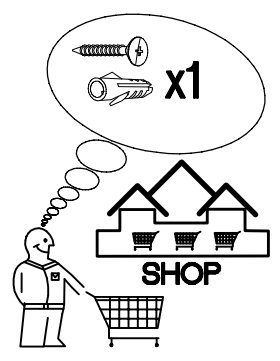
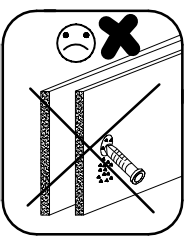
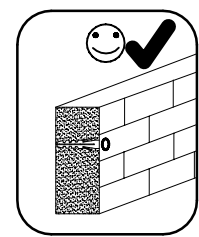
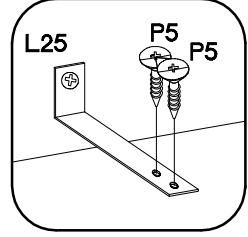

5.

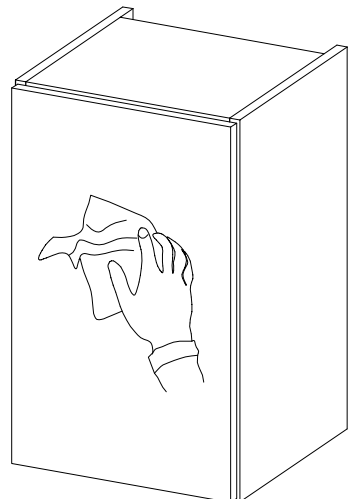
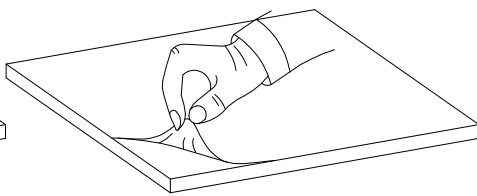
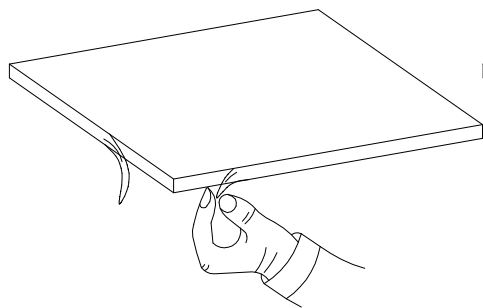
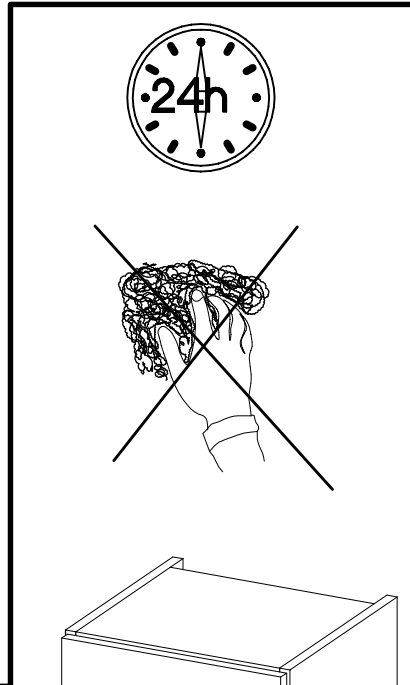
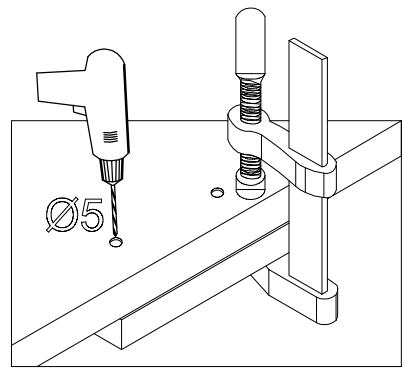
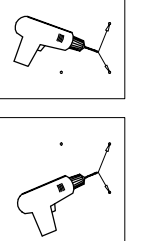
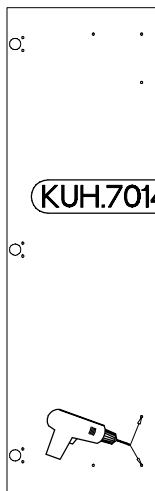
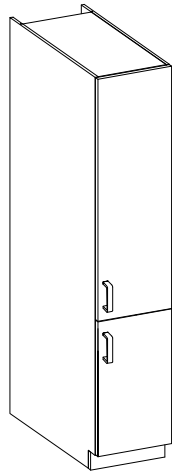
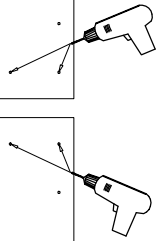
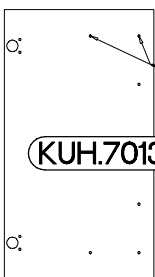
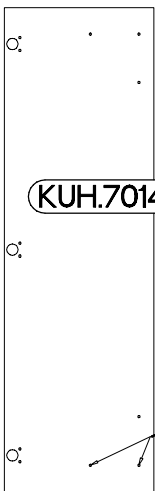
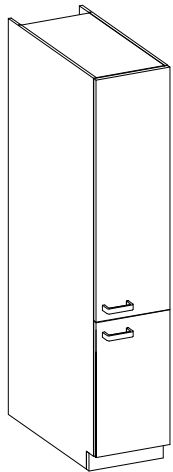
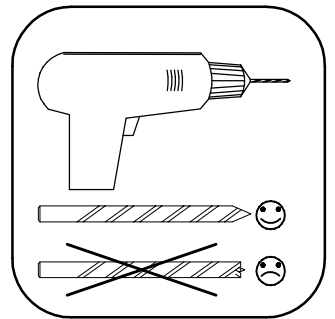
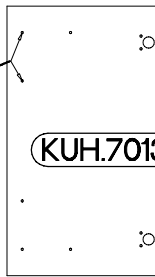
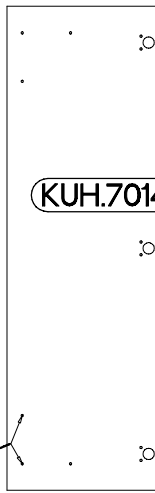
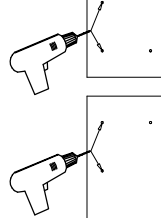
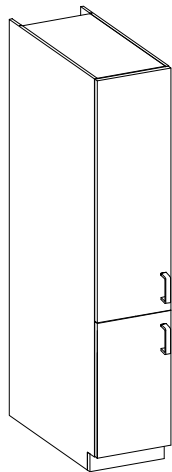
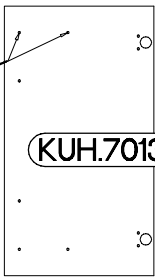
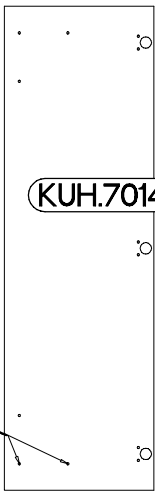
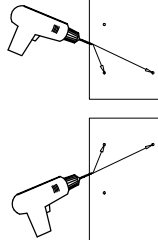
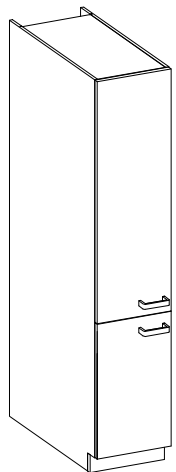



M4x22mm		
4	U	S23
4		2

