

SADR - C,D

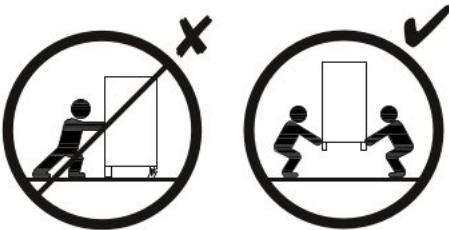

- Ⓓ **Montageanleitung**
- Ⓐ **Handleiding voor de montage**
- Ⓓ **Montaj talimatı**
- Ⓕ **Notice de montage**
- Ⓒ **Montážní návod**
- Ⓗ **Szerelési útmutató**
- Ⓒ **Assembly instructions**
- Ⓐ **Instrukcja montażu**
- Ⓒ **Инструкция по монтажу**
- Ⓘ **Istruzioni di montaggio**
- Ⓒ **Návod na montáž**
- Ⓓ **Instrucțiunile de montaj**
- Ⓔ **Instrucciones de montaje**
- Ⓓ **Montaj Talimatı**

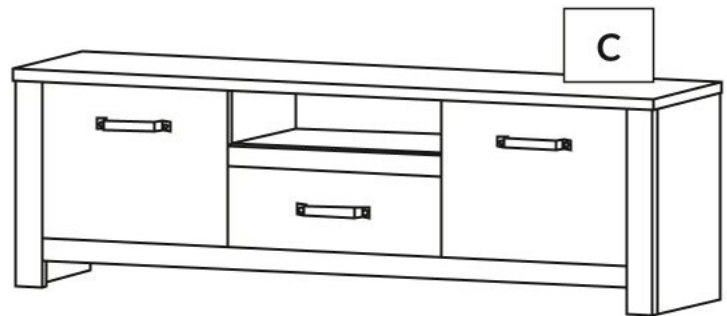

2022-01-28

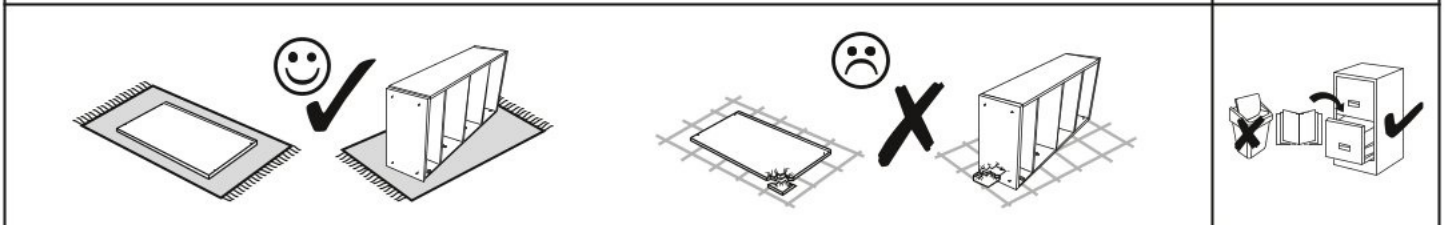
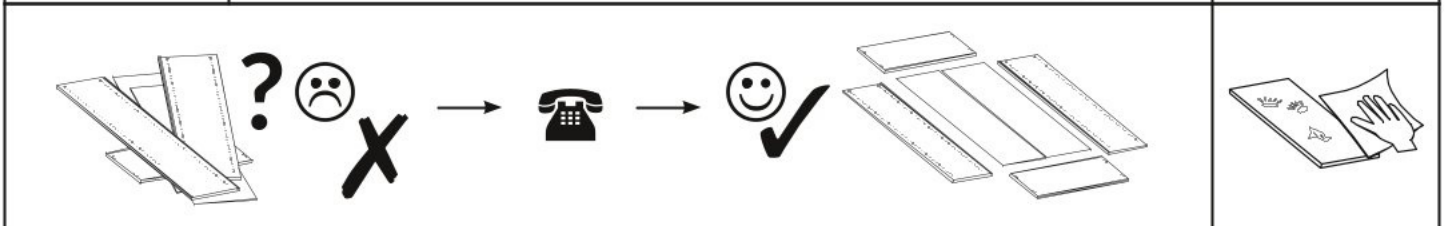
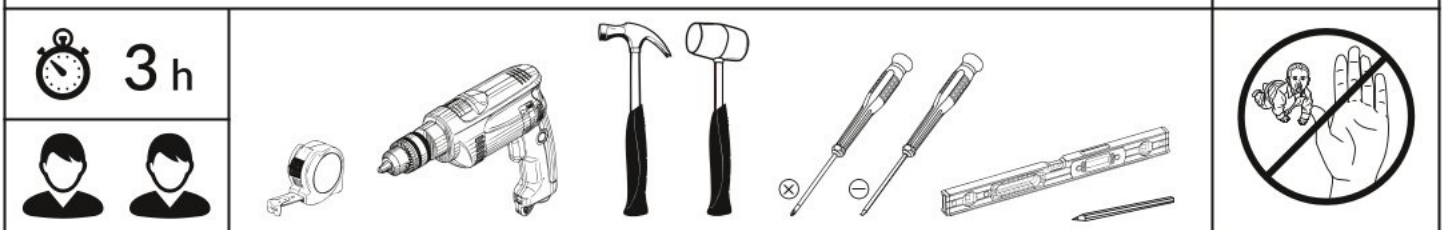



C:

A 7 x 50 mm x 4	B 8 x 32 mm x 30	C10 (R/D) x 4	DT x 4	E 3,5 x 13 mm 8	E2 3 x 20 mm x 22	E4 4 x 30 mm x 2	EP2 4 x 20 mm x 10	
EPM2 4 x 20 mm x 6	G2 x 4	G9 Ø 50/100 mm x 2	H1 x 5	K6 L=350 mm x 1	M x 3	R H=11 mm x 28	RB x 4	
T3 5 x 9 mm x 8	U L=24,3 mm x 28	XA x 1	ZR Ø 15 x 28					

D:

A 7 x 50 mm x 5	T2 5 x 10 mm x 4	V4 Ø 35 x 2	XA x 1
-------------------------------	--------------------------------	---------------------------	----------------------

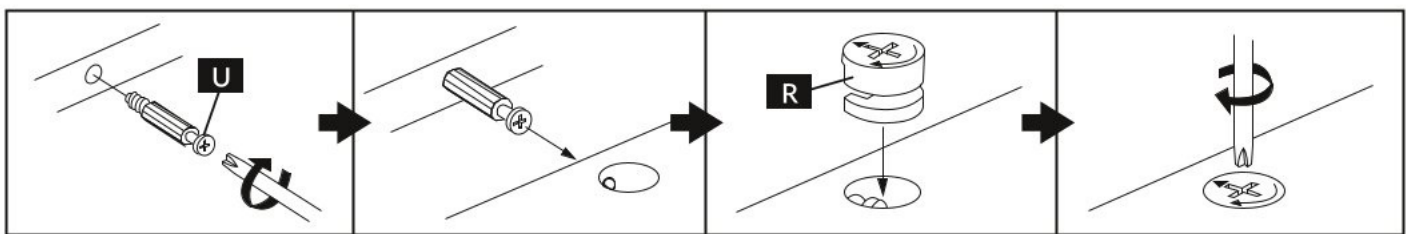
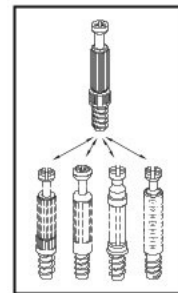
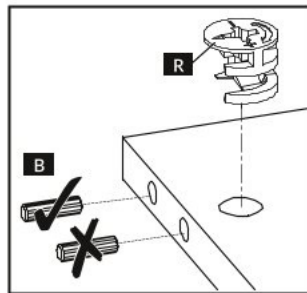
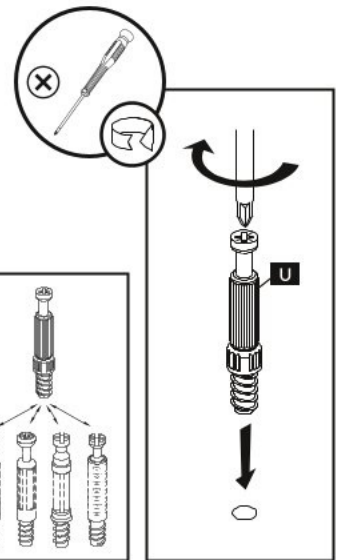
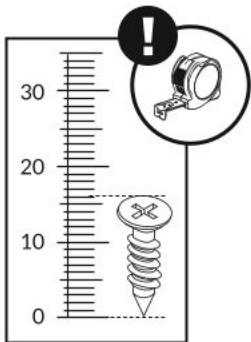
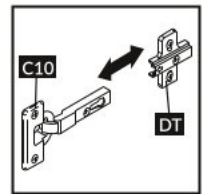
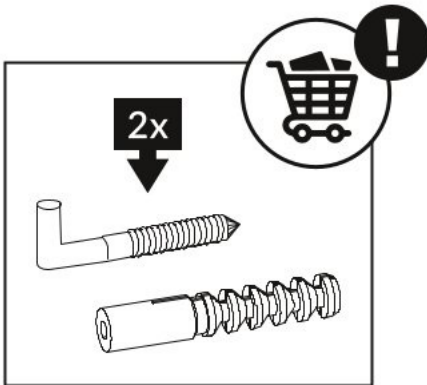



nr	↔[mm]	↓[mm]	∅[mm]	Menge	Colli
C-1	1608	363	16	x 1	1/1
C-2	544	363	16	x 1	1/1
C-3	1650	400	16	x 1	1/1
C-4	492	378	16	x 1	1/1
C-5	380	363	16	x 1	1/1
C-6	380	363	16	x 1	1/1
C-7	492	378	16	x 1	1/1
C-8L	492	65	19	x 1	1/1
C-8R	492	65	19	x 1	1/1
C-9	549	50	18	x 1	1/1
C-10	1510	50	18	x 1	1/1
C-11L	476	374	16	x 1	1/1
C-11R	476	374	16	x 1	1/1
C-12	1622	402	3	x 1	1/1
C-13	549	190	16	x 1	1/1
C-14	488	120	16	x 1	1/1
C-15	350	120	16	x 1	1/1
C-16	350	120	16	x 1	1/1
C-17	520	356	3	x 1	1/1
D-1	1370	165	16	x 1	1/1
D-2	1370	165	16	x 1	1/1

D - Vor Beginn der Möbelmontage sollten alle Elemente auf Beschädigungen überprüft werden. Wenn ein Element des Produkts beschädigt ist, installieren Sie das Produkt bitte nicht und reichen Sie eine Beschwerde ein. Die Installation des Produkts auf der Grundlage der beschädigten Elemente bedeutet, dass der Käufer seinen Zustand akzeptiert, was bedeutet, dass die Beschwerde über beschädigte Elemente nicht akzeptiert wird.

NL - Voordat u met de meubelmontage begint, moeten alle elementen op schade worden gecontroleerd. Als een onderdeel van het product beschadigd is, installeer het dan niet en dien een klacht in. Installatie van het product op basis van de beschadigde elementen betekent dat de koper hun staat accepteert, wat betekent dat de claim voor beschadigde elementen niet wordt geaccepteerd.

TR - Mobilya montajına başlamadan önce tüm elemanlarda hasar olup olmadığını kontrol edilmelidir. Ürünün herhangi bir parçası hasar görmüşse, lütfen ürünü kurmayınız ve şikayette bulununuz. Ürünün hasarlı elemanlar bazında montajı, Alıcının durumunu kabul ettiği anlamına gelir, bu da hasarlı elemanlar için talep kabul edilemeyeceği anlamına gelir.

F - Avant de commencer l'assemblage du meuble, tous les éléments doivent être vérifiés pour détecter tout dommage. Si un élément du produit est endommagé, veuillez ne pas installer le produit et déposer une plainte. L'installation du produit sur la base des éléments endommagés signifie que l'Acheteur accepte leur état, ce qui signifie que la réclamation d'éléments endommagés ne sera pas acceptée.

CZ - Před zahájením montáže nábytku je třeba zkontrolovat poškození všech prvků. Pokud je některý prvek produktu poškozen, zdržte se instalace produktu a podejte stížnost. Instalace výrobku na základě poškozených prvků znamená, že kupující akceptuje jejich stav, což znamená, že reklamace poškozených prvků nebude uznána.

HU - A bútorzszerelés megkezdése előtt ellenőrizni kell az összes elem sérülését. Ha a termék bármely eleme megsérült, kérjük, tartózkodjon a termék telepítésétől és nyújtson be panaszt. A termék sérült elemek alapján történő felszerelése azt jelenti, hogy a Vevő elfogadja azok állapotát, ami azt jelenti, hogy a sérült elemek igényét nem fogadják el.

GB - Before starting the furniture assembly, all elements should be checked for damage. If any element of the product is damaged, please refrain from installing the product and file a complaint. Installation of the product on the basis of the damaged elements means the Buyer's acceptance of their condition, which means that the complaint of damaged elements will not be accepted.

PL - Przed rozpoczęciem montażu mebla wszystkie elementy należy sprawdzić czy nie są uszkodzone. W przypadku wykrycia uszkodzenia elementu należy odstąpić od montażu mebla i złożyć reklamację. Montaż produktu w oparciu o uszkodzone elementy oznacza akceptację ich stanu przez Kupującego, co powoduje, że reklamacja uszkodzonych elementów nie będzie uznawana.

RU - Перед началом сборки мебели следует проверить все элементы на предмет повреждений. Если какой-либо элемент продукта поврежден, пожалуйста, воздержитесь от установки продукта и подайте жалобу. Установка товара на поврежденные элементы означает, что Покупатель принимает их состояние, а значит, претензии по поврежденным элементам не принимаются.

IT - Prima di iniziare l'assemblaggio del mobile, tutti gli elementi dovrebbero essere controllati per danni. Se qualche elemento del prodotto è danneggiato, astenersi dall'installare il prodotto e presentare un reclamo. L'installazione del prodotto sulla base degli elementi danneggiati implica l'accettazione da parte dell'Acquirente della loro condizione, il che significa che il reclamo per elementi danneggiati non sarà accettato.

SK - Pred začatím montáže nábytku by sa mali skontrolovať všetky prvky, či nie sú poškodené. Ak je niektorý prvok výrobku poškodený, neinstalujte výrobok a reklamujte ho. Inštalácia produktu na základe poškodených prvkov znamená, že Kupujúci akceptuje ich stav, čo znamená, že reklamácia poškodených prvkov nebude akceptovaná.

RO - Înainte de a începe asamblarea mobilierului, toate elementele trebuie verificate pentru a nu se deteriorează. Dacă vreun element al produsului este deteriorat, vă rugăm să vă abțineți de la instalarea produsului și să depuneți o reclamație. Instalarea produsului pe baza elementelor deteriorate înseamnă acceptarea de către Cumpărător a stării lor, ceea ce înseamnă că reclamația privind elementele deteriorate nu va fi acceptată.

ES - Antes de comenzar el montaje de los muebles, todos los elementos deben comprobarse en busca de daños. Si algún elemento del producto está dañado, absténgase de instalar el producto y presente una queja. La instalación del producto sobre la base de los elementos dañados supone la aceptación por parte del Comprador de su estado, por lo que no se aceptará la reclamación de elementos dañados.

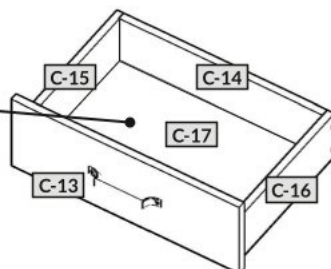
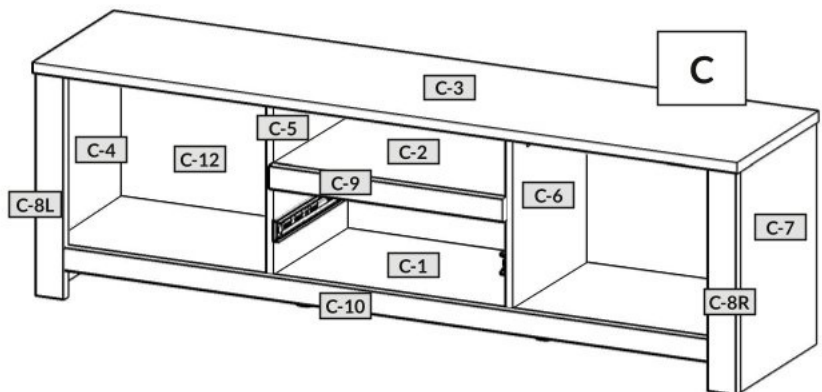
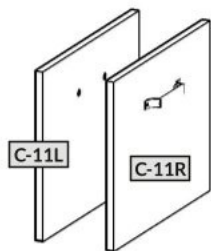
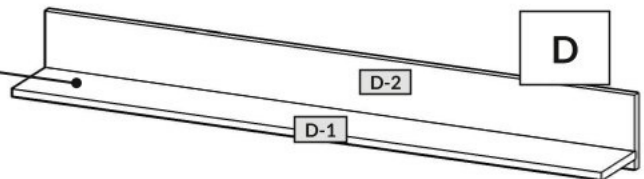



1

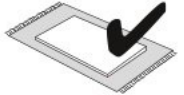
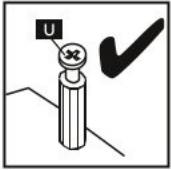
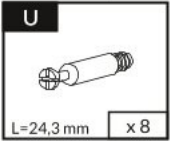
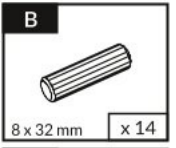
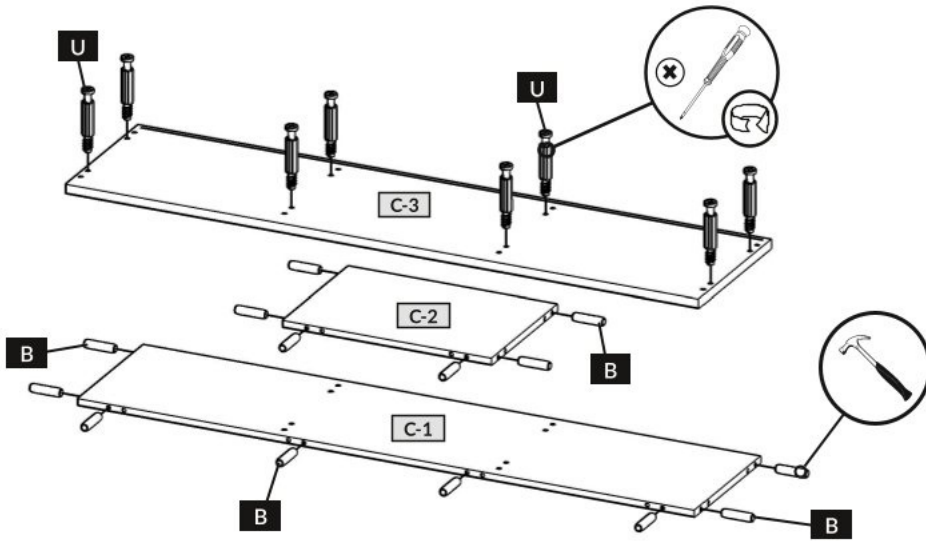

2

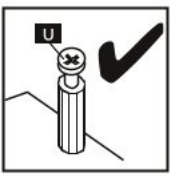
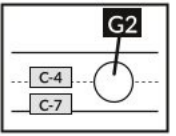
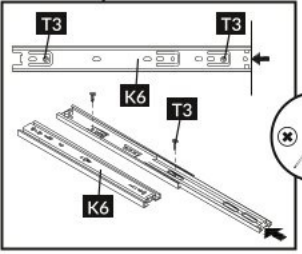
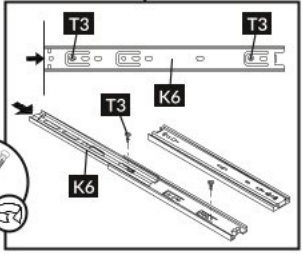
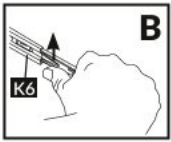
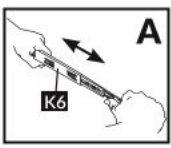
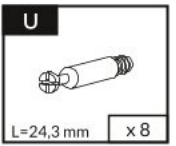
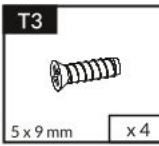
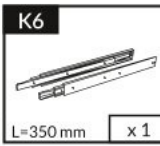
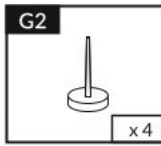
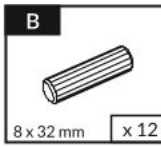
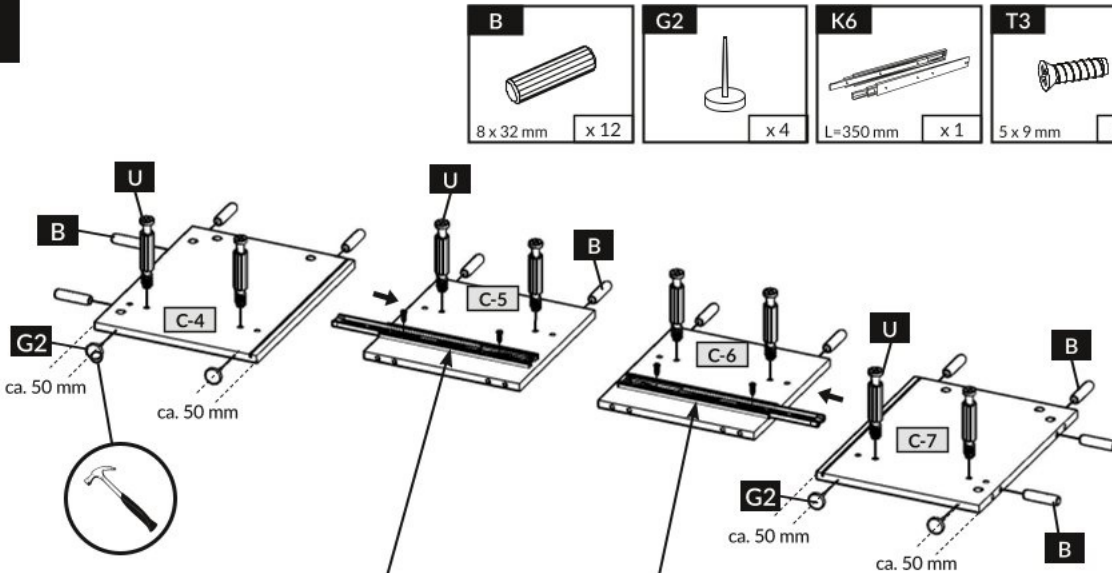

3

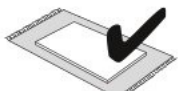
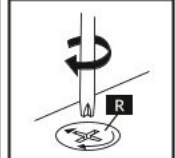
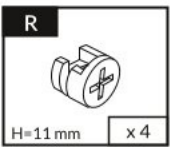
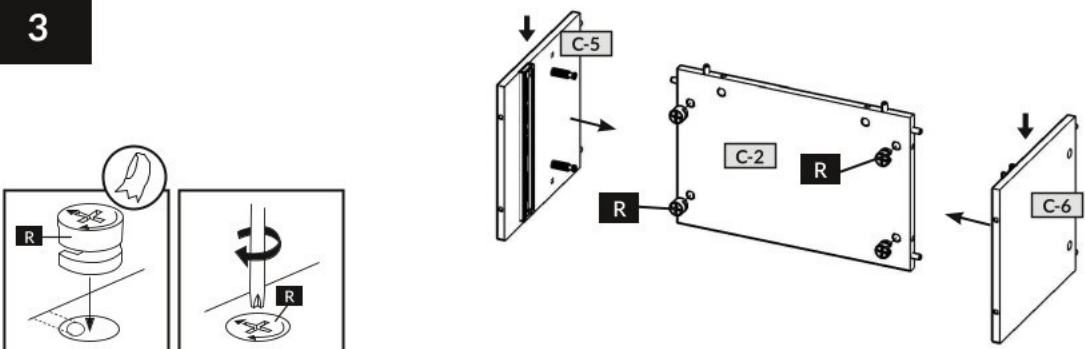



4

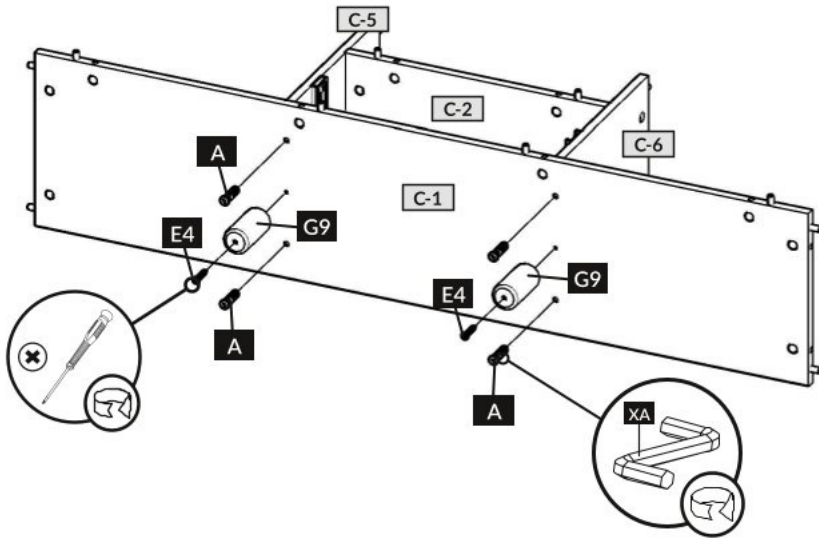

- | | |
|---------------------------------|-------------------------------|
| A
7 x 50 mm
x 4 | E4
4 x 30 mm
x 2 |
| G9
Ø 50/100 mm
x 2 | XA
x 1 |

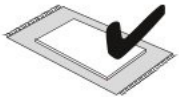

5

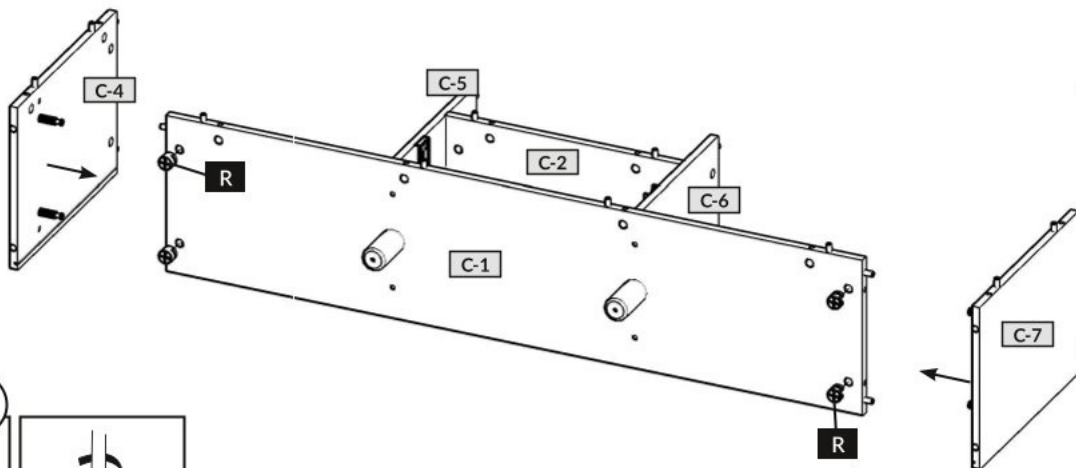

- | |
|----------------------------|
| R
H=11 mm
x 4 |
|----------------------------|

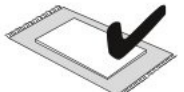

6

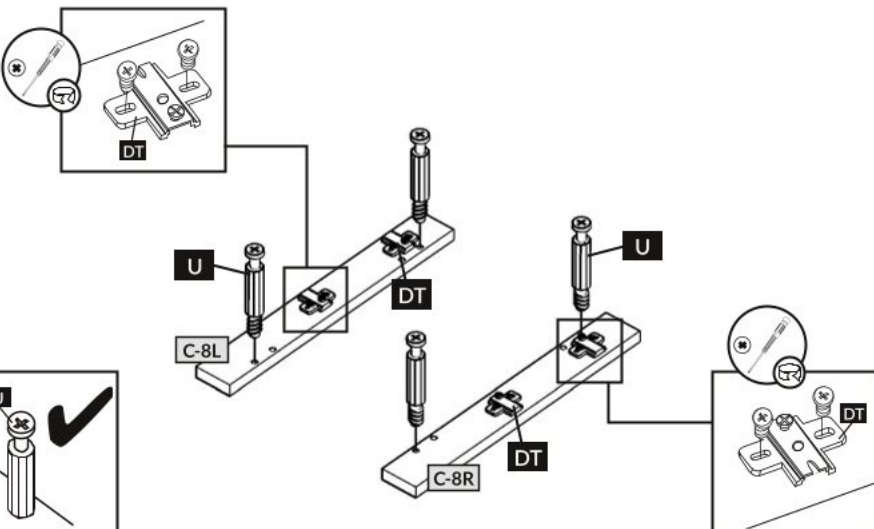
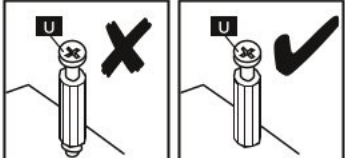

- | |
|------------------------------|
| DT
x 4 |
| U
L=24,3 mm
x 4 |

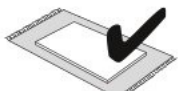



7

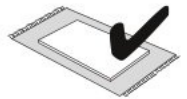
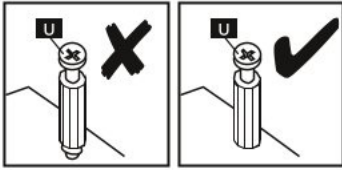
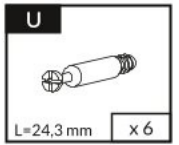
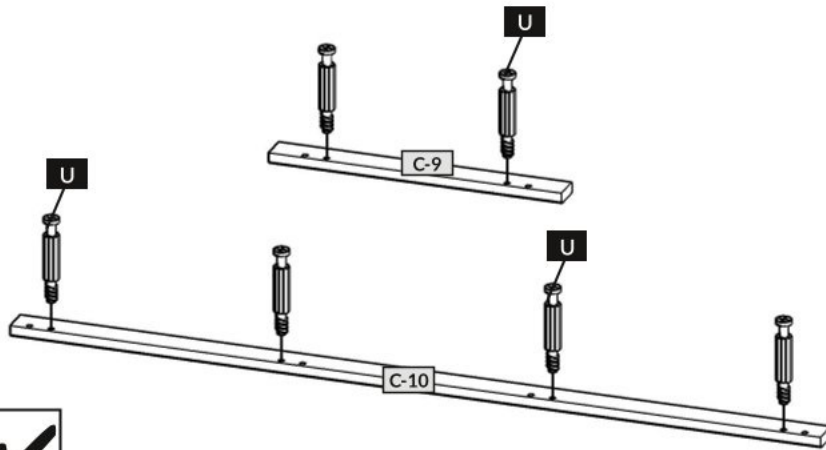

8

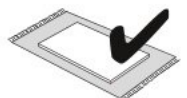
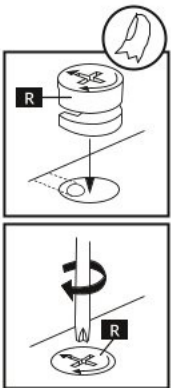
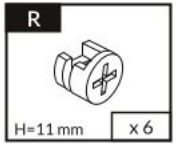
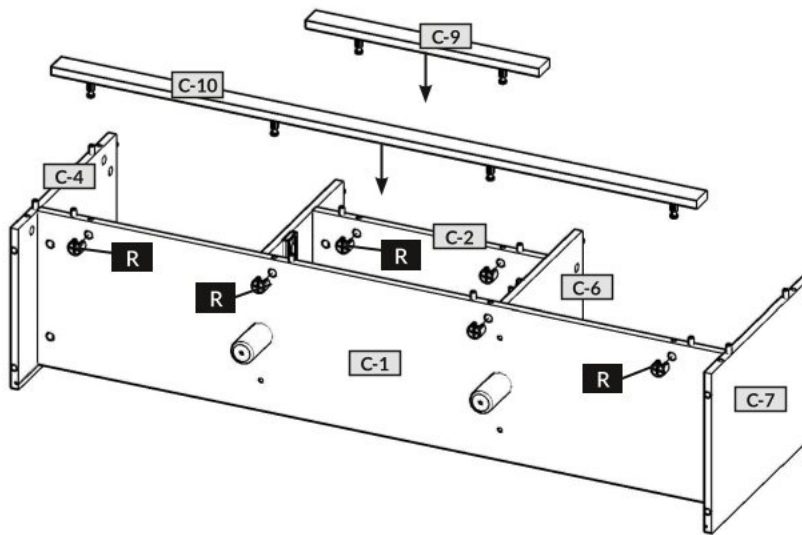

9

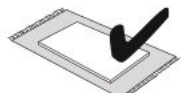
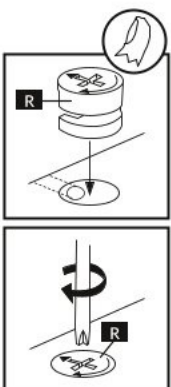
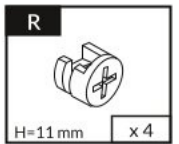
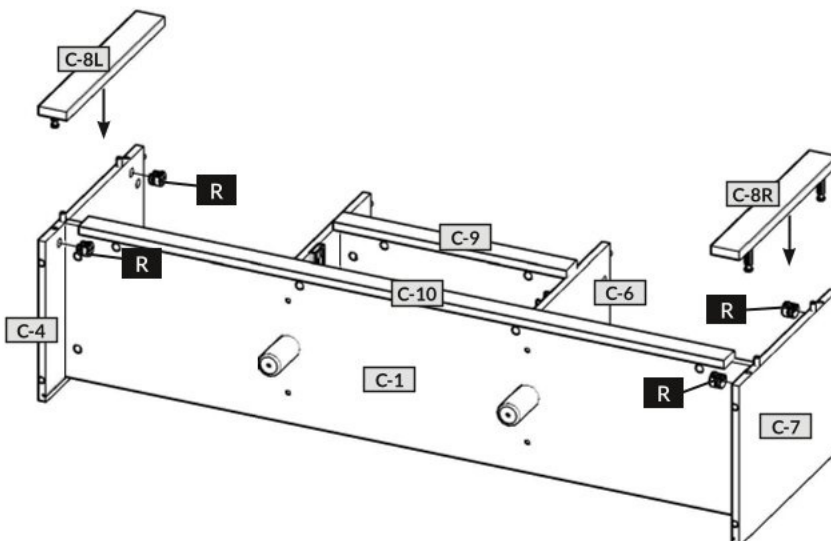



10

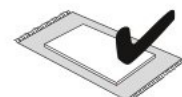
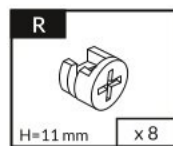
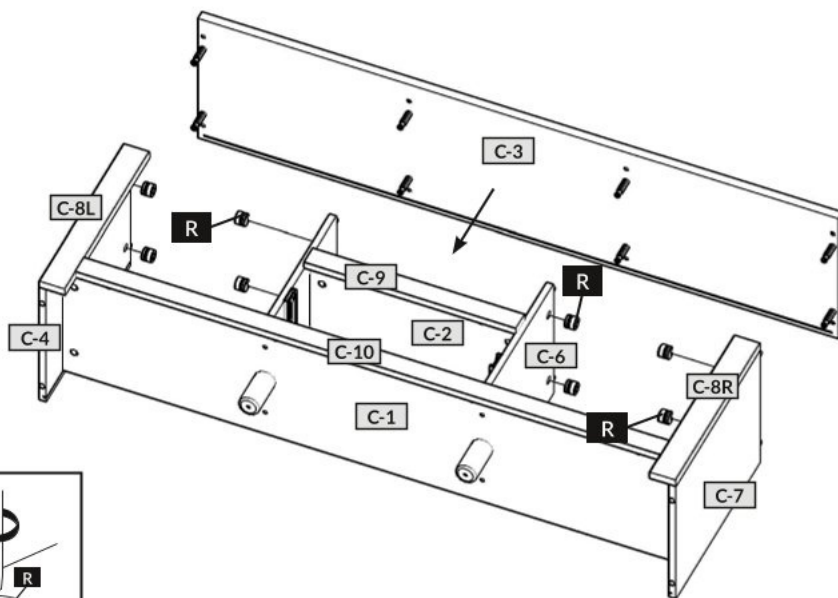
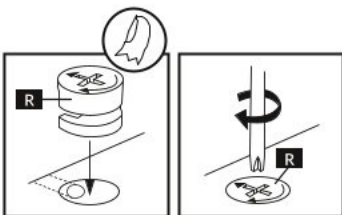

11

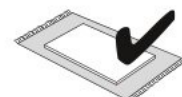
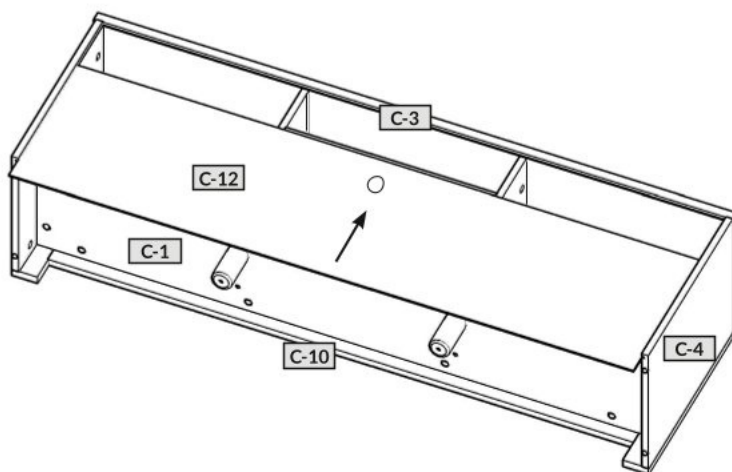

12

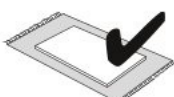
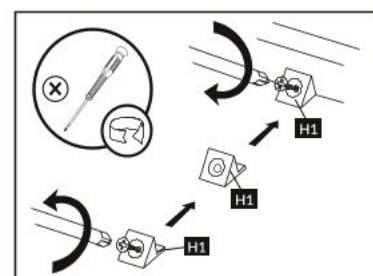
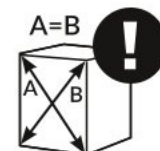
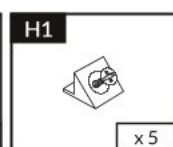
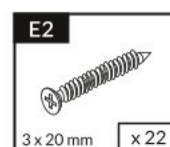
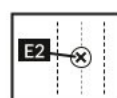
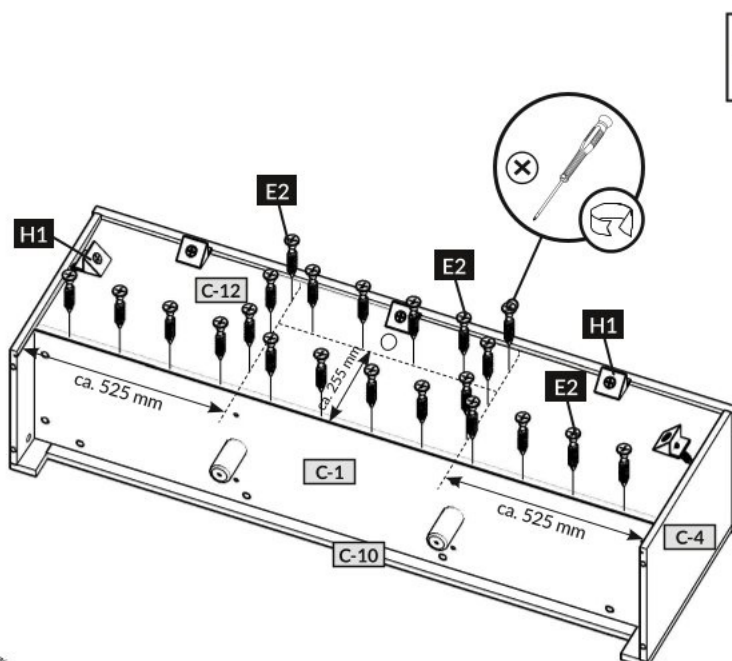



13

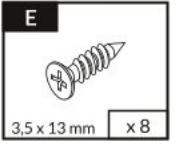
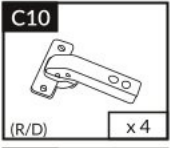
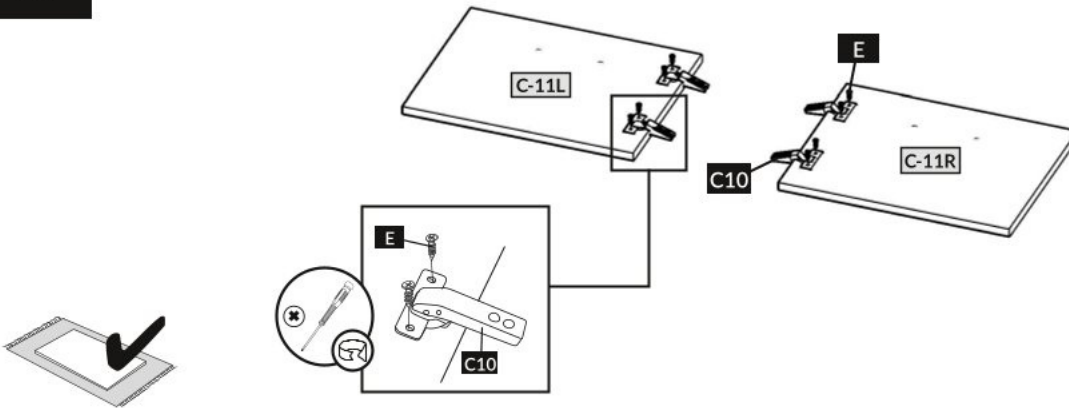

14

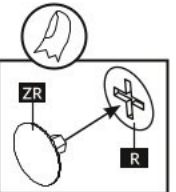
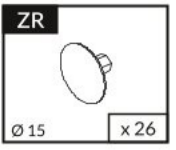
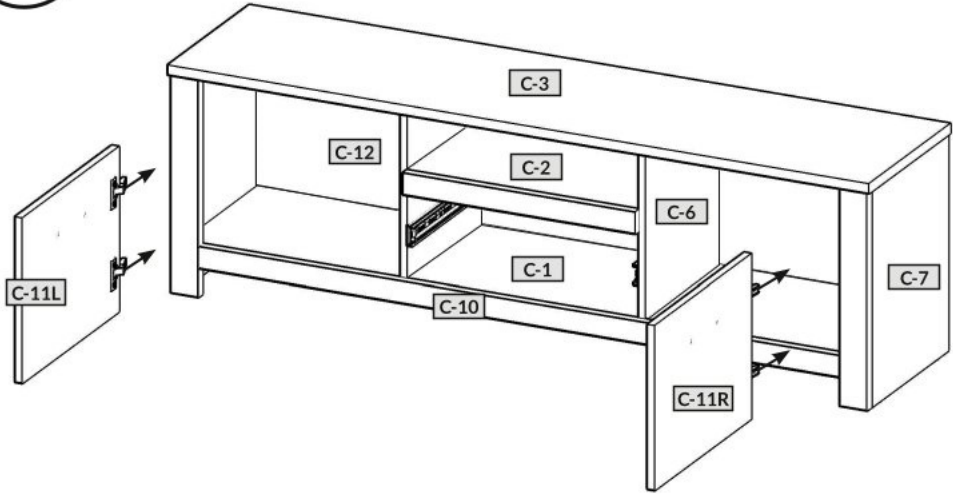
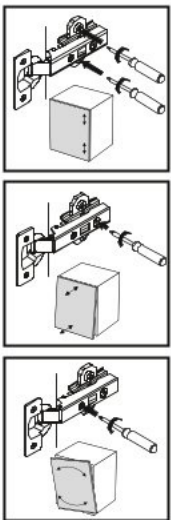

15

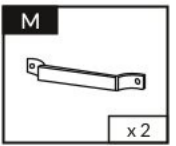
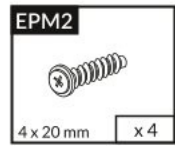
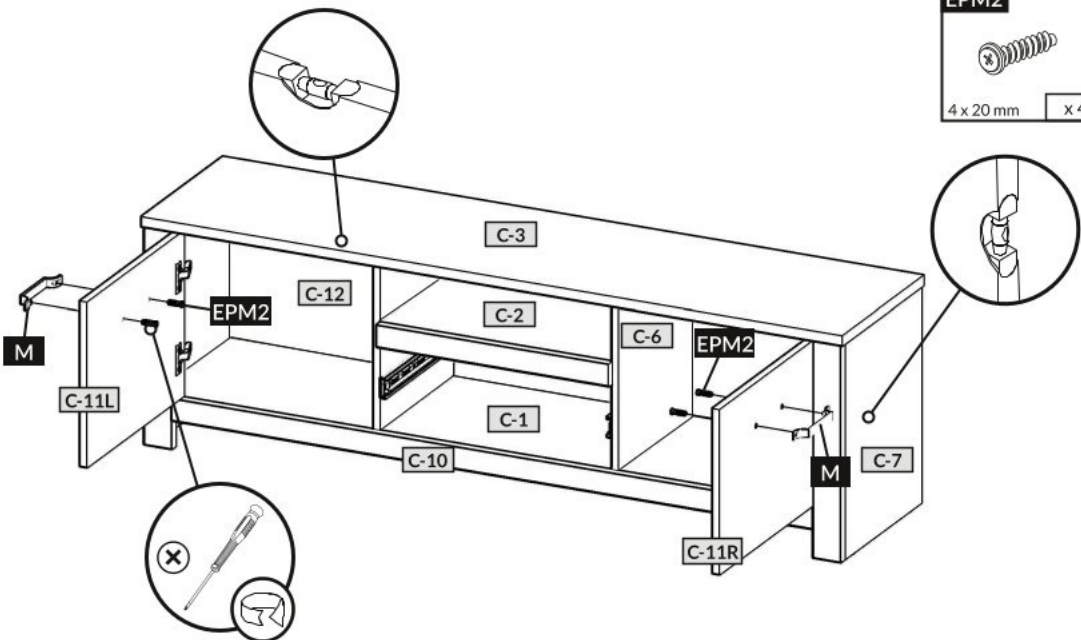



16

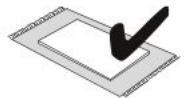
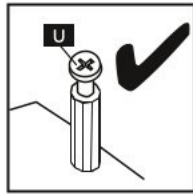
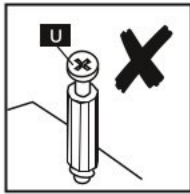
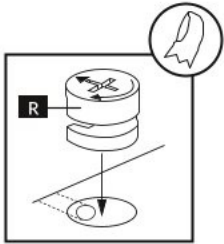
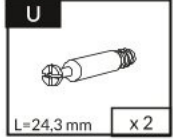
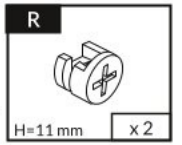
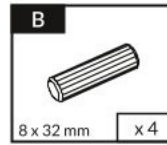
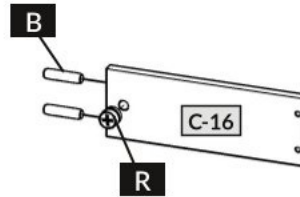
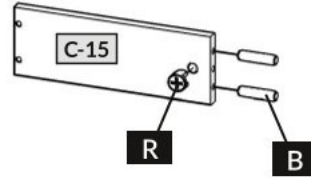
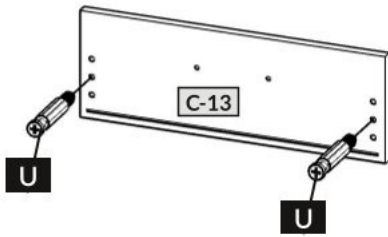

17

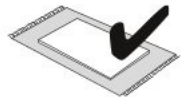
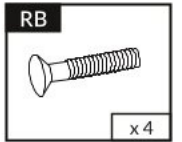
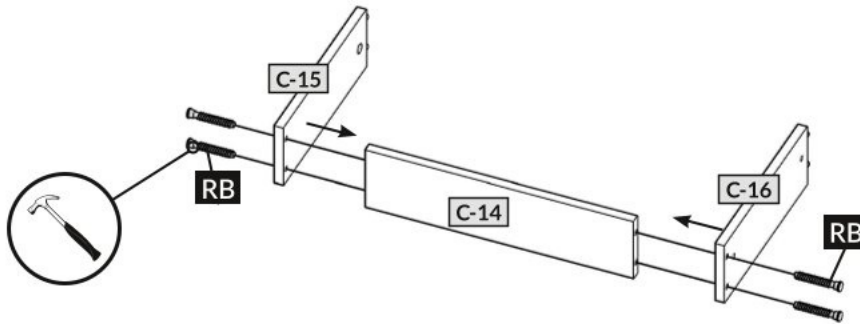

18

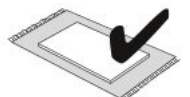
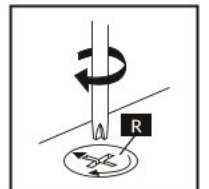
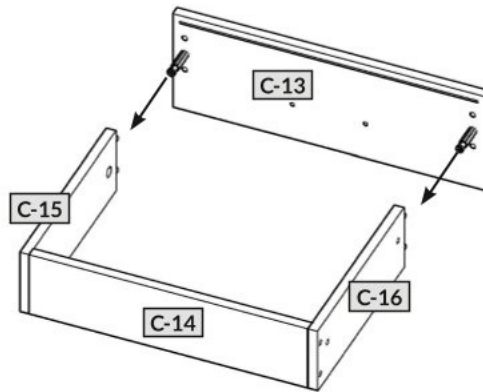

19

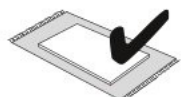
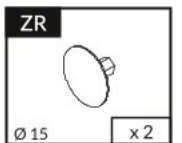
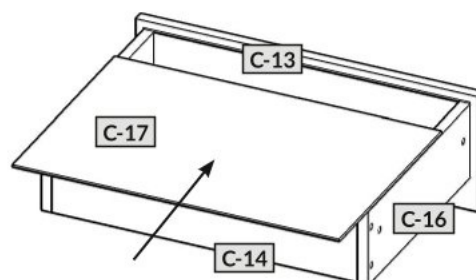
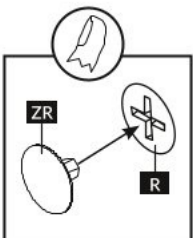



20

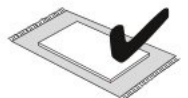
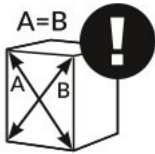
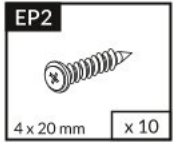
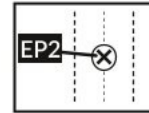
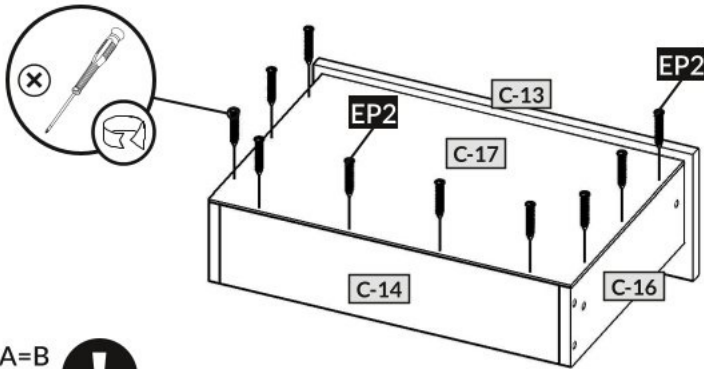

21

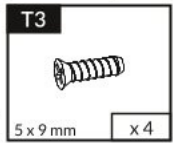
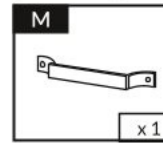
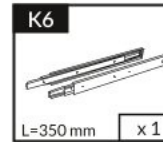
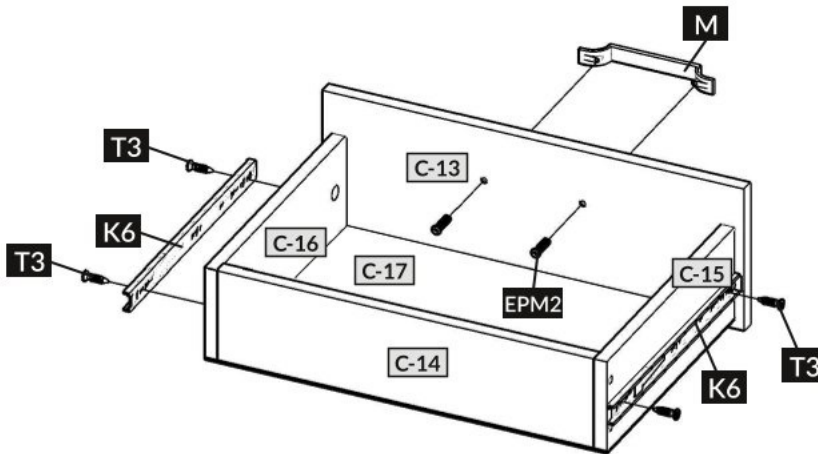

22

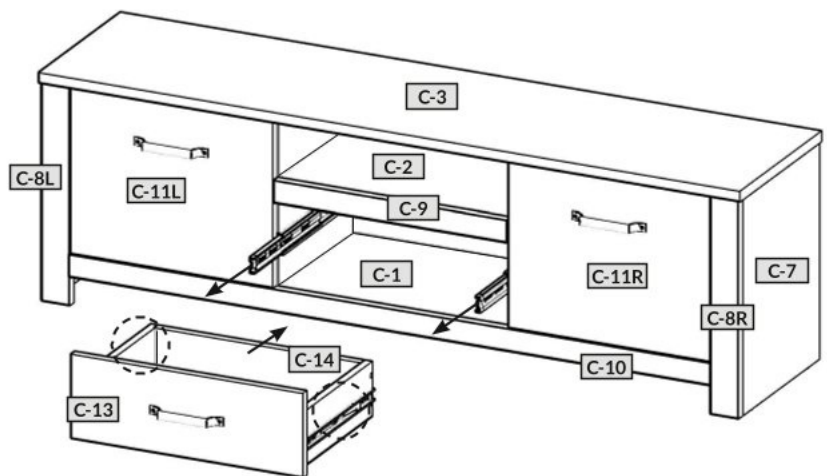
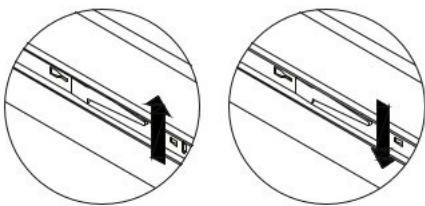



1

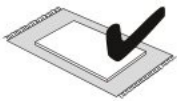
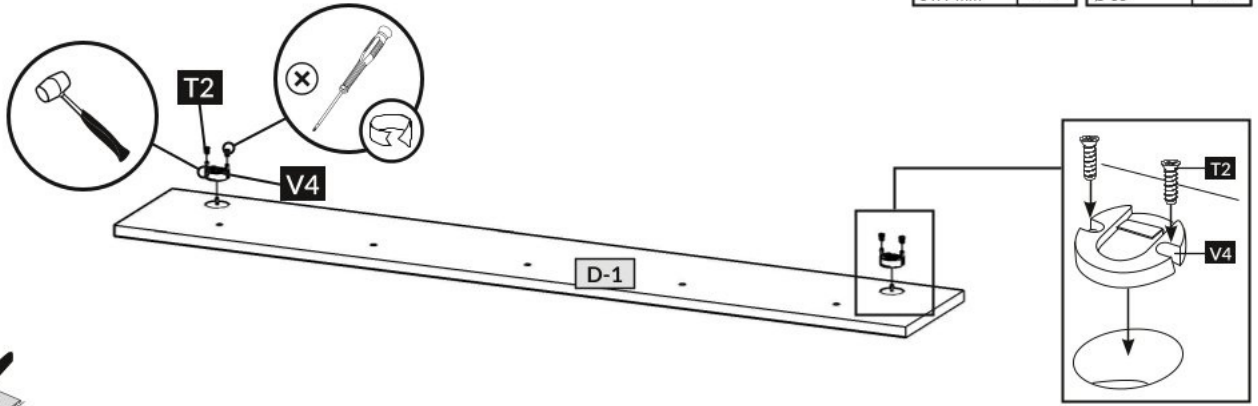
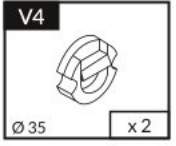
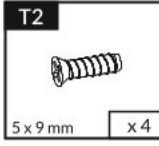

2

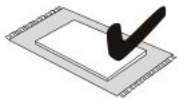
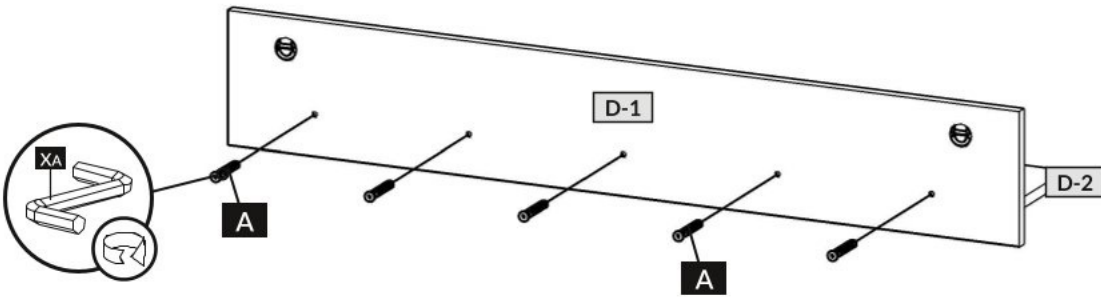
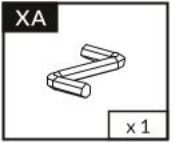
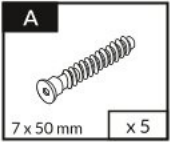

3

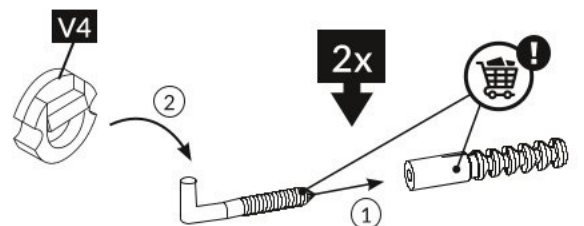
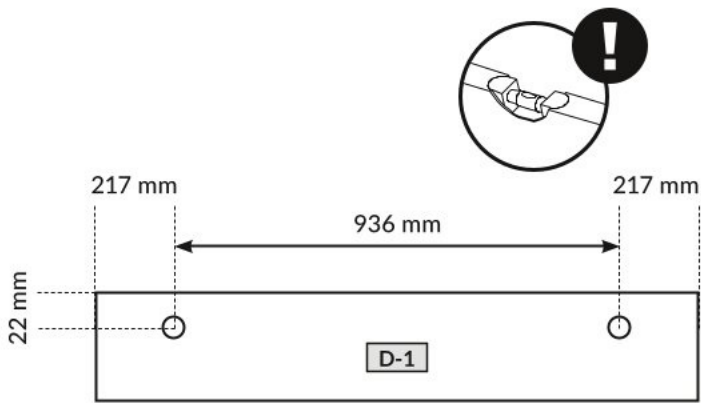
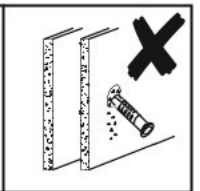
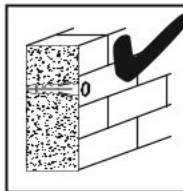

Name • Nom • Nome • Naam • Nazwa • Имяно
• Názov • Név • Denumire • Isim • Название

Nr • No • N° • Номер • Č • Sz

Typ • Type • Tip • Típus • Тип • Tun

SADR

— —

C, D

D Unser Directservice für Beschlagteile
Sollte Ihnen ein Beschlagteil fehlen, können Sie diese Servicekarte
direct an die untenstehende Nummer senden. Wir können allerdings
nur Beschlagteile auf diesem Weg verschicken. Sollen Sie eine andere
Bearbeitung an Ihrem Möbelstück haben, so wenden Sie sich bitte
direkt an Ihr Möbelhaus.

GB Our direct order service for fitting
If a fitting should be missing to you, you know this service map
directly following number faces. We can in this way send away
however only fitting. If you should have another objection to your
piece of furniture, then they turn please to your furniture house.

CZ Naše přímé služby pro kování
Chybí-li vám nějaký díl z kování, můžete tuto servisní kartu odeslat
přímo na níže uvedenou adresu. Touto cestou však můžeme rozeslat jen
díly kování. Pokud máte další reklamaci jiný díl nábytku, obraťte se přímo
na svého prodejce nábytku.

F Bien étudier la notice de montage
Rassemblez les pièces constituant votre meuble. Regroupez et contrôlez la
quantité. Munissez - vous de l'outillage nécessaire. Aménagez -
vous une zone de montage. Procédez au montage. Ne jamais forcer
les assemblages. Resserrez les vis après quelques temps d'usage.
Gardez votre notice de montage, si une pièce venait à manquer, elle
serait le plus clair moyen de communiquer avec votre magasin.

I Il nostro servizio diretto per l'ordine delle ferramenta
Nel caso vi mancassero dei pezzi, potete spedire (ex questa carta) dei
servizi direttamente al seguente numero. Per altri reclami al vostro
mobile, potete rivolgervi al vostro mobilificio.

BG Директно обслужаване на отделили отдели "Обзор"
Ако ви недостига някой от отделилите, довършителни или други отдели
можете да ги поръчите на този адрес - номер, докато до-услуга. До това
нямаме право да приемем други отдели или отдели. Ако имате други
жалби относно мебелта, моля, обърнете се директно към вашия
продавач на мебели.

NL Onze directservice voor losse onderdelen
Wanneer er een onderdeel mist kunt u deze servicekaart direct aan
onderstaand nummer sturen. Wij kunnen alleen langs deze weg
onderdelen versturen. Mocht u een ander probleem aan uw meubel
hebben verzoeken wij u contact op te nemen met uw meubeldealer.

PL Nasz bezpośredni serwis części montażowych
Jeżeli brakuje części koniecznych do montażu, prosimy o przesłanie
nam tej karty serwisowej na niżej podany numer faxu. Możemy w ten
sposób przysłać państwu tylko brakujące części. W przypadku innych
objawów dotyczących mebla, prosimy o zgłoszenie ich do salonu
meblowego w którym został dokonany zakup.

HR Servis za okove
U slučaju da nedostaje neki od dijelova molimo vas da na dole
navedeni fax broj posaljete ovaj servisni obrazac. Na ovaj način mogu
se dostaviti samo okovi. U slučaju da imate dodatna prigovore vezane
uz komad namještaja molimo vas da se obratite izravno trgovini
namještaja gdje je isti kupljen.

HU Direktrendelési munkavégzés esetén
Ha hiányzik egy vasalat, ezt a kártyát közvetlenül eljuttathatja az esztbe
jelölt telefonszámra. Azonban csak a vasalásokat tudunk így küldeni.
Amennyiben másféle reklamáció áll fenn bútorrendelését illetően,
forduljon közvetlenül a bútorházzal.

SK Naše priamy servis pro částí kovania
Ak by Vám chýbala nejaká časť kovania, môžete poslať túto servisnú
kartu poslať faxom priamo na nižšie uvedené číslo faxu. Dlely
kovania vieme poslať iba týmto spôsobom. Ak by ste mali inú
reklamáciu ohľadom Vašho nábytku, obráťte sa priamo na Vašu
predajňu nábytku.

SLO Naše direktno služne storitve za okovje
Ca vam manjka kakšno okovje, lahko to servisno kartico pošljete po
faksu direktno na spodnjo številko. Po tej poti vam lahko pošljemo
samo okovje. Če želite reklamirati kakšen drug del pohištva, se obrnite
neposredno na vašo trgovino pohištva.

RO Service-ul nostru direct pentru feronerie
In cazul in care va lipsesc o piesa de feronerie puteti sa trimitem
direct acest card de service pe fax la numarul de mai jos. Noi nu
putem expedia piesa de feronerie decit pe acestul cale. Dacă aveți o
altă reclamație referitoare la piesa de mobilier, atunci vă rugăm să vă
adresați direct la magazinul dvs. de mobilier.

RUS Наш прямой сервис для поставок фурнитуры
Если окажется, что Вам не хватает того или иного элемента
фурнитуры, Вы можете отправить сервисную карту по факсу
непосредственно на нижеприведенный номер. Однако, таким
образом мы можем пересылать лишь фурнитуру. Если же у Вас
возникнут иные претензии относительно приобретенной мебели,
пожалуйста, обращайтесь непосредственно в организацию,
осуществившую продажу.

S Vår directservice för beslagst ler
Om du saknar en beslagst l kan du f ra detta servicekort direkt till
numret som anges ned. T nk p  att detta  r den enda m jigheten att
skicka beslagst ler till dig. Om du vill reklamera din m bel  r en
annan anledning m ste du kontakta ditt m belhus direkt.

ES Nuestro servicio directo para accesorios
Si le falta alg n accesorio, puede enviar esta tarjeta de servicio
directamente a la siguiente direcci n. No obstante, por este m todo
solo podemos enviar accesorios. Si tiene alguna otra objecci n sobre su
mueble, consulte directamente con su muebler a.

TR Donatilar i n dogrudan servisi
E r donatilar eksikse bu servis kartini dogrudan asagida bulunan
adrese dogrudan mail yzabilmirsiniz. Secece bu yolla donatilar
g nderilebiliriz. Mobilyaniza baska sikayetleriniz varsa l tfen dogrudan
mobilya satilciniza daniliniz.

C:

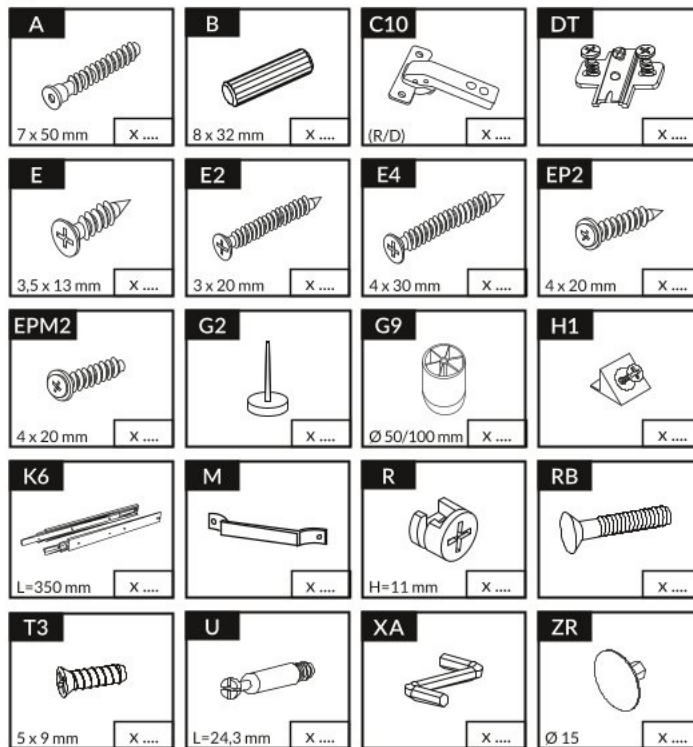

D:

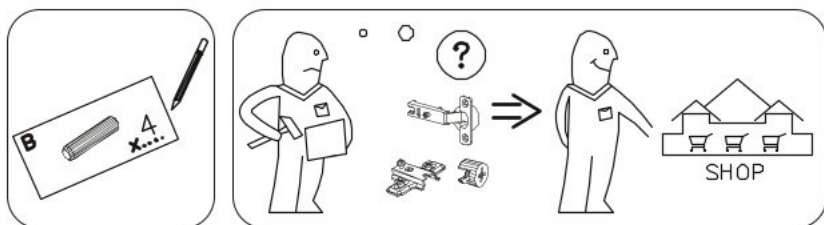
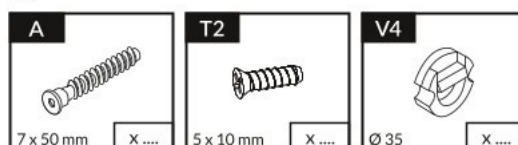

Name • Nom • Nome • Naam • Nazwa • Имяно
• Názov • Név • Denumire • Isim • Название

Nr • No • N° • Номер • Č • Sz

Typ • Type • Tip • Típus • Тип • Tun

SADR

— —

C, D

D Unser Direktservice für Beschlagteile
Sollte Ihnen ein Beschlagteil fehlen, können Sie diese Servicekarte
direct an die untenstehende Nummer senden. Wir können allerdings
nur Beschlagteile auf diesem Weg verschicken. Sollen Sie eine andere
Bearbeitung an Ihrem Möbelstück haben, so wenden Sie sich bitte
direkt an Ihr Möbelhaus.

GB Our direct order service for fitting
If a fitting should be missing to you, you know this service map
directly following number faces. We can in this way send away
however only fitting. If you should have another objection to your
piece of furniture, then they turn please to your furniture house.

CZ Naše přímé služby pro kování
Chybí-li vám nějaký díl z kování, můžete tuto servisní kartu odfaxovat
přímo na níže uvedeně číslo. Touto cestou však můžeme rozeslat jen
díly kování. Pokud byste reklamovali jiný díl nábytku, obraťte se přímo
na svého prodejce nábytku.

F Bien étudier la notice de montage
Respectez les pièces constituant votre meuble. Regroupez et contrôlez la
quincaillerie. Munissez - vous de l'outillage nécessaire. Aménagez -
vous une zone de montage. Procédez au montage. Ne jamais forcer
les assemblages. Resserrez les vis après quelques temps d'usage.
Gardez votre notice de montage, si une pièce venait à manquer, elle
serait le plus clair moyen de communiquer avec votre magasin.

I Il nostro servizio diretto per l'ordine delle ferramenta
Nel caso vi mancassero dei pezzi, potete spedire (ex) questa carta di
servizi direttamente al seguente numero. Per altri reclami al vostro
mobile, potete rivolgervi al vostro mobilificio.

BG Директно обслужаване на отделили отдели "Обзор"
Ако ви липнеат некои од деловите, додвојини картичката директно
преку факс на адресот на долу наведеното место. Можеме да ви
доставим само делови. Ако имате друга жалба за вашиот
мебел, молиме да се обратите директно на вашиот продавач на
мебел.

NL Onze directservice voor losse onderdelen
Wanneer er een onderdeel mist kunt u deze servicekaart direct aan
onderstaand faxnummer sturen. Wij kunnen alleen langs deze weg
onderdelen versturen. Mocht u een ander probleem aan uw meubel
hebben verzoeken wij u contact op te nemen met uw meubeldealer.

PL Nasz bezpośredni serwis części montażowych
Jeżeli brakuje części koniecznych do montażu, prosimy o przesłanie
nam tej karty serwisowej na niżej podany numer faxu. Możemy w ten
sposób przysłać państwu tylko brakujące części. W przypadku innych
objawów dotyczących mebla, prosimy o zgłoszenie ich do salonu
meblowego w którym został dokonany zakup.

HR Servis za okove
U slučaju da nedostaje neki od dijelova molimo vas da na dole
navedeni fax broj pošaljete ovaj servisni obrazac. Na ovaj način mogu
se dostaviti samo okovi. U slučaju da imate dodatna prigovore vezane
uz komad namještaja molimo vas da se obratite izravno trgovini
namještaja gdje je isti kupljen.

HU Direktdarabizlatunk vasalatoz eszelen
Ha hiányzik egy vasalat, ezt a kártyát közvetlenül elfaxolhatja az alább
jelölt faxszámra. Azonban csak a vasalatozat tudunk így küldeni.
Amennyiben másfélejt reklamáció áll fenn bútordejarabjéit illetően,
forduljon közvetlenül a bútorházzal.

SK Naše přímý servis pro částí kování
Ak by Vám chýbala nejaká časť kovania, môžete poslať túto servisnú
kارتو priamo na nižšie uvedené číslo faxu. Můžeme v ten
spůsob poslat' vašímu týmu správcům. Ak by ste mali inú
reklamáciu ohľadom vášho nábytku, obraťte sa priamo na vašu
predajnú nábytku.

SLO Naše direktno služba storitve za okovje
Ca vam manjka kakšno okovje, lahko to servisno kartico pošljete po
faksu direktno na spodnjo številko. Po tej poti vam lahko pošljemo
samo okovje. Če želite reklamirati kakšen drug del pohištva, se obrnite
neposredno na vašo trgovino pohištva.

RO Service-ul nostru direct pentru feronerie
In cazul in care va lipsesc o piesa de feronerie puteti sa trimitem
direct acest card de service pe fax la numarul de mai jos. Noi nu
putem expedia piesa de feronerie decat pe acestul cale. Dacă aveți o
altă reclamație referitoare la piesa de mobilier, atunci vă rugăm să vă
adresați direct la magazinul dvs. de mobilă.

RUS Наш прямой сервис для поставок фурнитуры
Если окажется, что Вам не хватает того или иного элемента
фурнитуры, Вы можете отправить сервисную карту по факсу
непосредственно на нижеприведенный номер. Однако, таким
образом мы можем переслать лишь фурнитуру. Если же у Вас
возникнут иные претензии относительно приобретенной мебели,
пожалуйста, обращайтесь непосредственно в организацию,
осуществившую продажу.

S Vår direktservice för beslagstiller
Om du saknar en beslagdel kan du faxa detta servicekort direkt till
numret som anges ned. Tank på att detta är den enda möjligheten att
skicka beslagstiller till dig. Om du vill reklamera din möbel av en
annan anledning måste du kontakta ditt möbelhus direkt.

ES Nuestro servicio directo para accesorios
Si le falta algún accesorio, puede enviar esta tarjeta de servicio
directamente a la siguiente dirección. No obstante, por este método
solo podemos enviar accesorios. Si tiene alguna otra objeción sobre su
mueble, consulte directamente con su mueblista.

TR Donatınız için doğrudan servisimiz
Bir donatınız eksikse bu servis kartını doğrudan aşağıda bulunan
adresle doğrudan mail yzabilirsiniz. Sadece bu yolla donatılar
gönderilebilir. Mobilyanızda başka şikayetleriniz varsa lütfen doğrudan
mobilya satıcınıza danışın.

nr	↔ [mm]	↓ [mm]	∟ [mm]	Menge	Colli
C-1	1608	363	16	x 1	1/1
C-2	544	363	16	x 1	1/1
C-3	1650	400	16	x 1	1/1
C-4	492	378	16	x 1	1/1
C-5	380	363	16	x 1	1/1
C-6	380	363	16	x 1	1/1
C-7	492	378	16	x 1	1/1
C-8L	492	65	19	x 1	1/1
C-8R	492	65	19	x 1	1/1
C-9	549	50	18	x 1	1/1
C-10	1510	50	18	x 1	1/1
C-11L	476	374	16	x 1	1/1
C-11R	476	374	16	x 1	1/1
C-12	1622	402	3	x 1	1/1
C-13	549	190	16	x 1	1/1
C-14	488	120	16	x 1	1/1
C-15	350	120	16	x 1	1/1
C-16	350	120	16	x 1	1/1
C-17	520	356	3	x 1	1/1
D-1	1370	165	16	x 1	1/1
D-2	1370	165	16	x 1	1/1

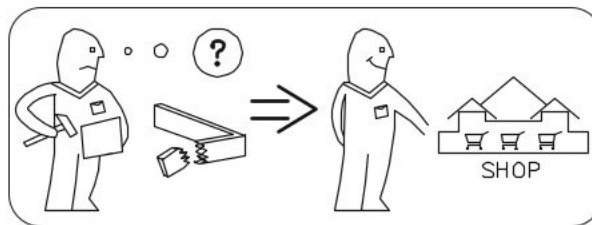
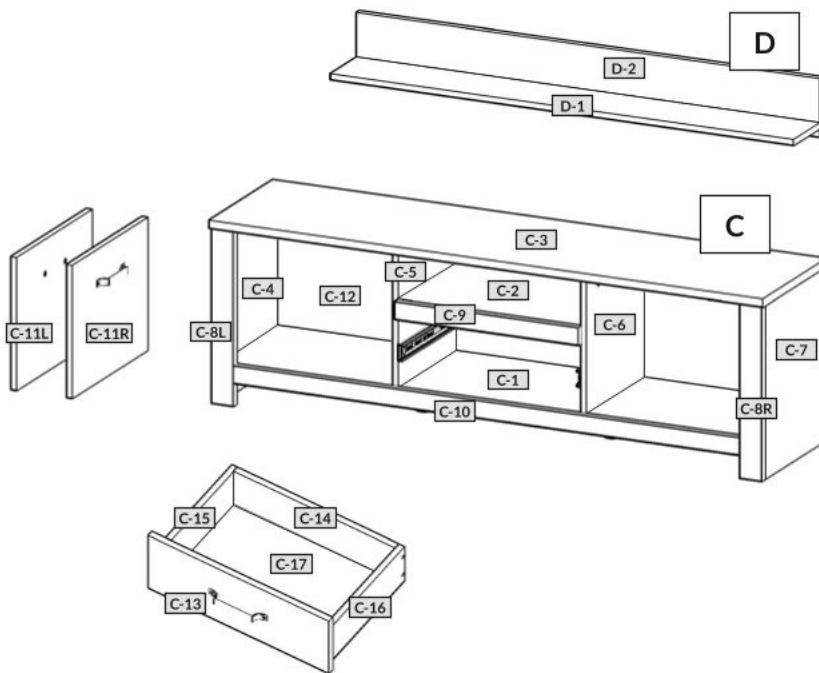



Achtung • Opgelet • Uwaga • Dikkat • Вниманіе •
Attention • Upozorneni • Figyelem • Allenzione • Atentie



D	Überschreiten Sie die angegebenen Maximalbelastungen nicht. Andernfalls kann das Möbelstück beschädigt oder zerstört werden.
GB	Do not exceed the maximum loads specified. Otherwise, the furniture may sustain damage or be irreparably damaged.
NL	Overschrijd de aangegeven maximale belastingen niet. Anders kan het meubelstuk worden beschadigd of vernield.
PL	Nie wolno przekraczać podanych maksymalnych wartości obciążenia. W innym przypadku można mebel uszkodzić lub zniszczyć.
TR	Belirtilen azami yuk degerini asmayiniz, aksi taktirde mobilya parçasi zarar gorebilir veya kullanilamaz hale gelebilir.
RU	Не допускается превышение указанных максимальных нагрузок. В противном случае возможно повреждение или разрушение мебели.
FR	Ne dépassez pas les charges maximum indiquées. Sinon, le meuble peut être endommagé ou détruit.
CZ	Nepřekračujte uvedená maximální zatížení. V opačném případě může dojít k poškození nebo zničení nábytku.
HU	Tartsa be az engedélyezett maximális terhelhetőséget/teljesítményt. Különben a bútor és annak alkatrészei megsérülhetnek, tönkre mehetnek.
IT	Non superare il carico massimo indicato. Altrimenti il mobile rischia di rovinarsi o frantumarsi.
RO	Nu depasiti sollicitarile maxime specificate. Altfel puteti sa deteriorati sau sa distrugeti piesa de mobilier.
SK	Neprekročte uvedené maximálne zaťaženia. V opačnom prípade sa môže nábytok poškodiť alebo zničiť.
D	Die Befestigung des Möbelstückes an der Wand muss von einer fachkundigen Person vorgenommen werden, da für die Montage an die Wand angepasste Dübel erforderlich sind.
GB	A qualified professional is required when mounting furniture to the wall since dowels corresponding to the wall are required for this.
NL	Een vakkundige persoon dient het meubelstuk aan de muur te bevestigen; voor de montage aan de muur zijn immers aangepaste pluggen vereist.
PL	Mocowanie mebla do ściany mogą przeprowadzić wyłącznie wykwalifikowane osoby, z uwagi na zastosowanie odpowiednio dopasowanych kołków do rodzaju ściany.
TR	Mobilya parçasının duvara sabitlenmesi, duvar montajı için özel uyarlanmış dübeller gerektirdiğinden bu iş sadece bu konuda uzman bir kişi tarafından gerçekleştirilmelidir.
RU	Поскольку для монтажа на стене необходимо использовать специальные дюбели, мебель должна быть закреплена на стене квалифицированным персоналом.
FR	La fixation du meuble contre le mur doit être effectuée par une personne compétente car, pour le montage mural, il faut utiliser des chevilles adaptées.
CZ	Montáž nábytku na stěnu musí provést odborník, protože k montáži na stěnu jsou zapotřebí upravené hmoždinky.
HU	A bútorelemek falra rögzítését szakembernek kell végeznie, mert a rögzítéshez megfelelő tiplít kell használni.
IT	Il fissaggio del mobile alla parete deve essere eseguito esperte, dato che occorrono tasselli adeguati.
RO	Fixarea la perete a piesei de mobilier se realizeaza numai de catre personal competent, deoarece montajul de perete necesita dibluri adecvate.
SK	Upevnenie nábytku na stenu musí vykonať odborník, nakoľko sú pre montáž na stenu potrebné vhodné hmoždinky.

