

FOTEL

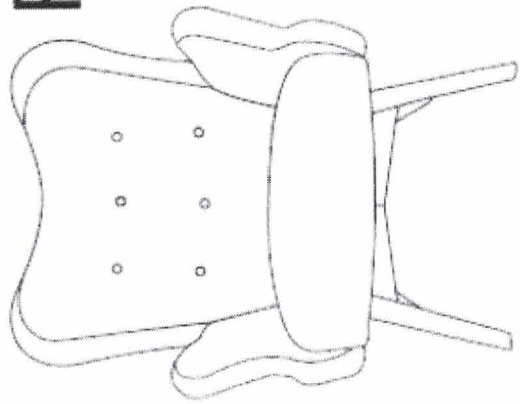

A



4szt

B

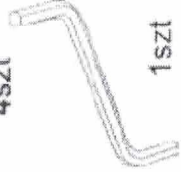

1szt

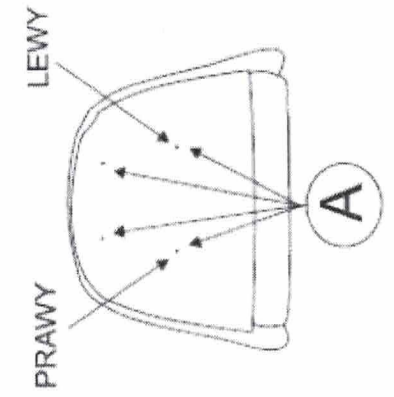
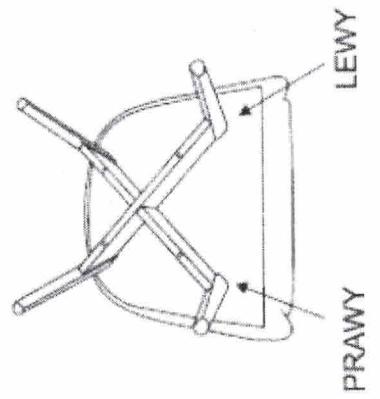
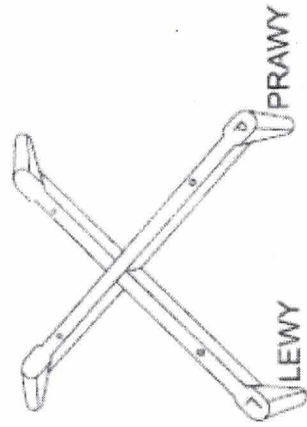
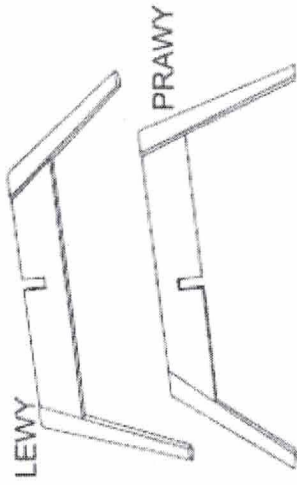

FOTEL

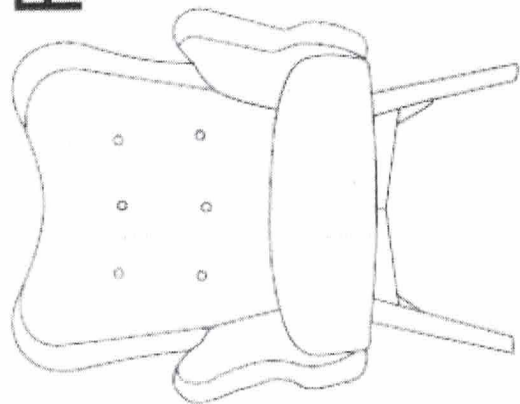

A



4szt

B

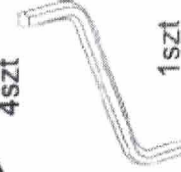

1szt

