

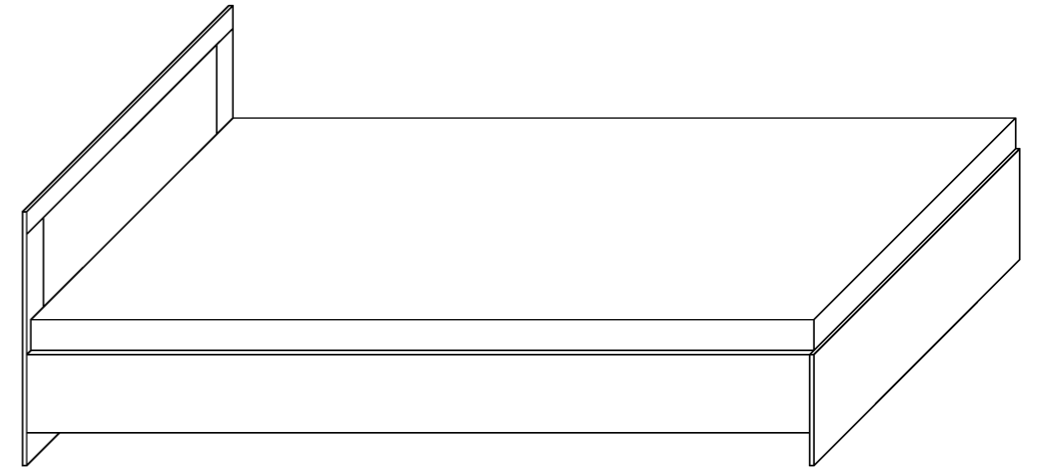

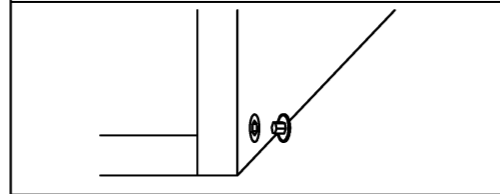

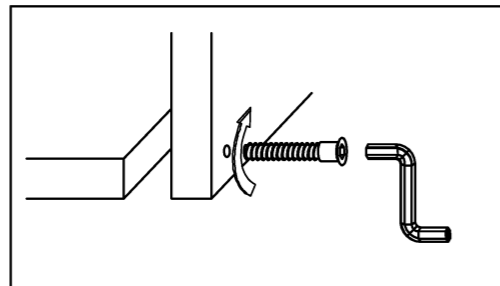

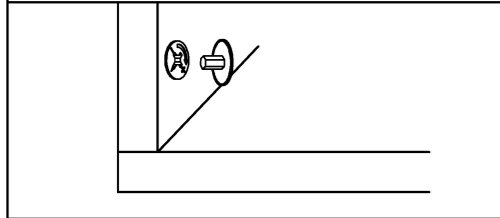

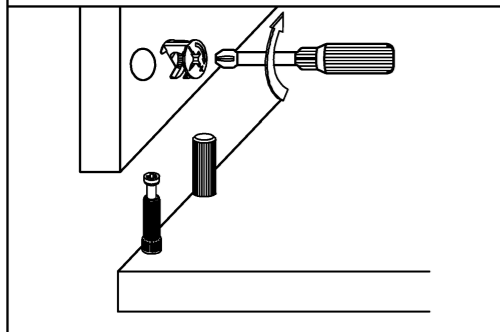
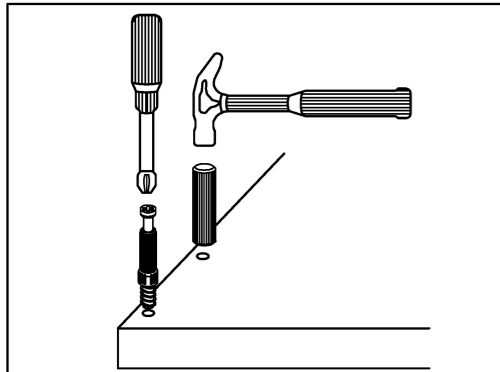
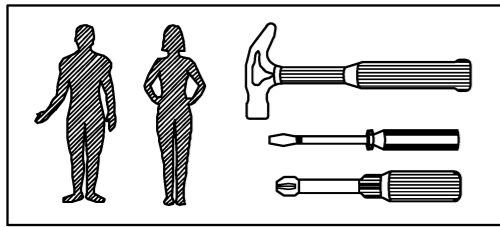

C22, C23

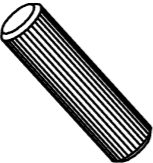

											
16	16	16	34	16	2	4	4	7x50 8	1	W6x30 4	4

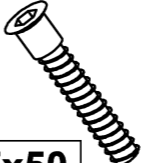
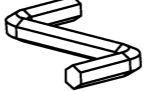
1

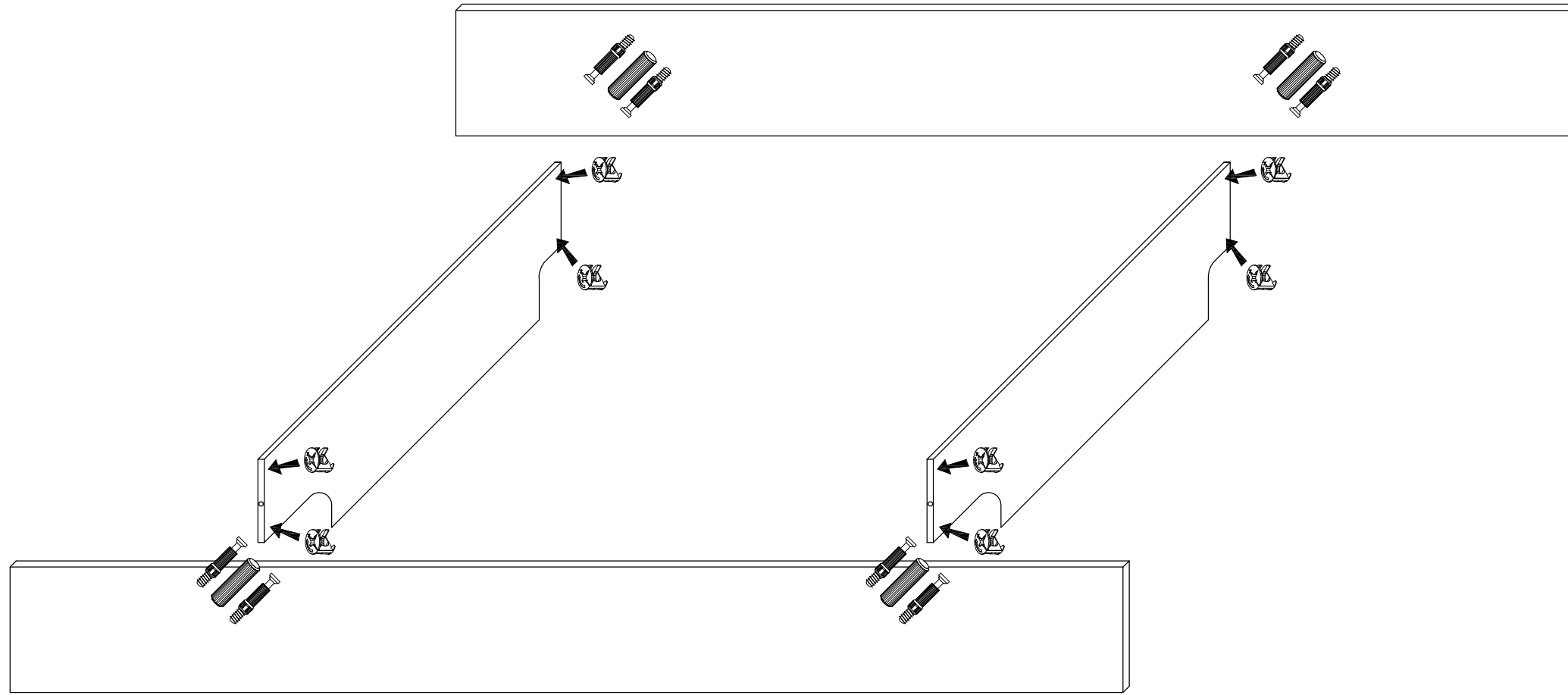

2

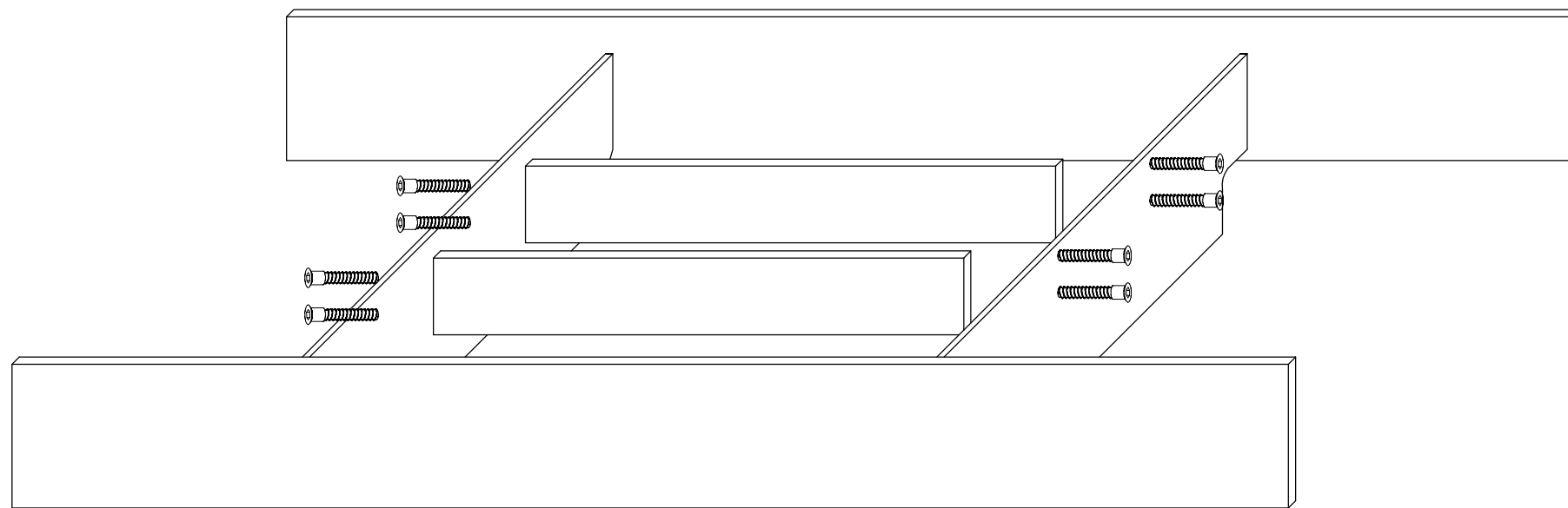

3

