

CAPS

S153-REG1D2S

A	B	C	D	
1	S153-011	433	188	1/3
2	S153-012	433	188	1/3
3	S153-013	1484	433	1/3
4	S153-117	1948	399	1/3
5	S153-118	1948	399	1/3
6	S153-202	500	403	2/3
7	S153-302	438	383	2/3
8	S153-315	438	364	2/3
9	S153-316	437	364	2/3
10	S153-573	1484	49	3/3
11	S153-578	188	49	3/3
12	S153-580	70	49	3/3
13	S153-904	400	348	2/3
14	S153-910	1912	464	1/3
15	ZS2-511	350	120	2/3
16	ZS2-512	350	120	2/3
17	ZS2-5582	389	120	2/3

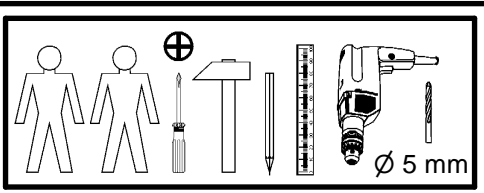
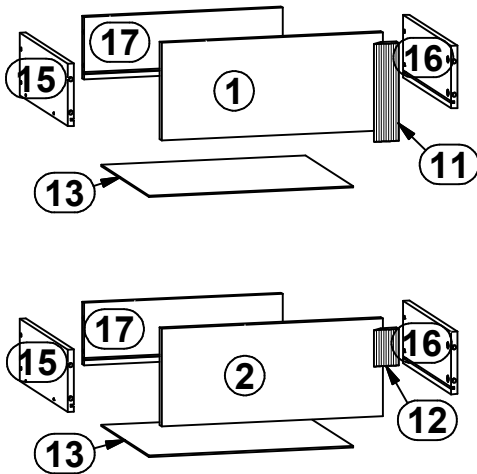
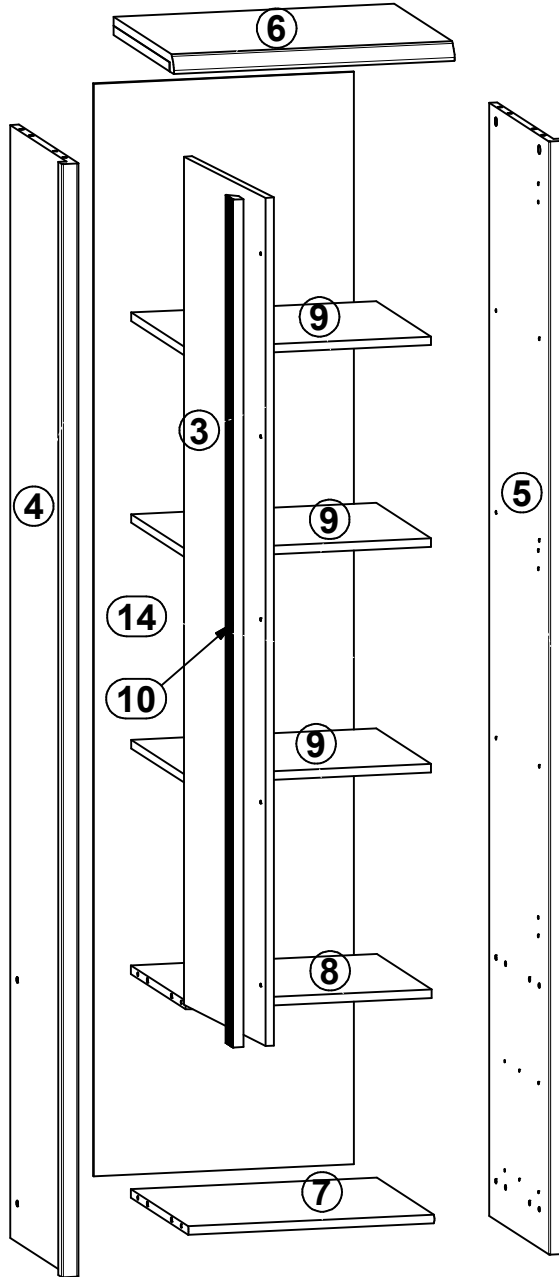
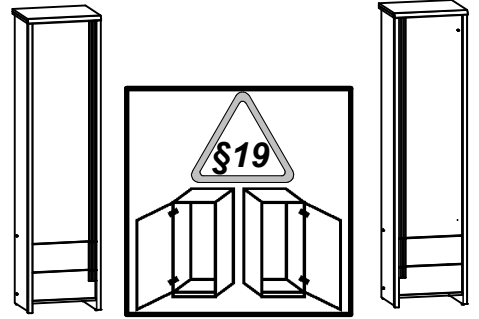

3x K16 a43	3x b19	12x φ5x17 mm d1	8x φ7x50 mm e1	8x φ5x9 mm e19	6x φ6,3x13 mm e2	12x φ6x13 mm e3	12x φ8x30 mm f1	8x φ6,5x40 mm f25
4x k1	55x l1	6x φ3,5x15 mm p51	9x φ4x22 mm p60	4x φ1,5x12mm #16 r1	8x φ12x10,5mm #12 r15	12x r42	2x 350 mm w45\CL	2x 350 mm w45\CR
2x 350 mm w45\DL	2x 350 mm w45\DR	1x z1	1x n26\1	1x φ3,5x16 mm p38	8x s1	4x ø16 s2		

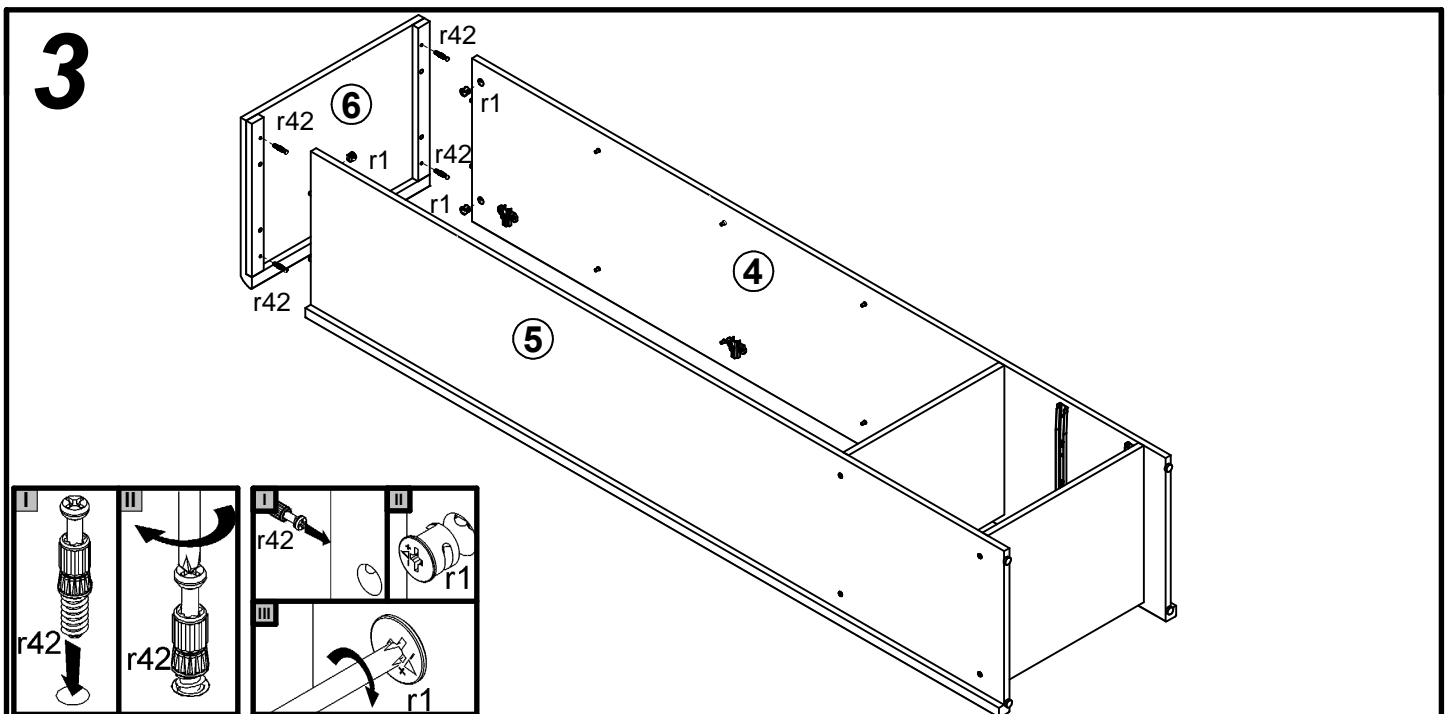
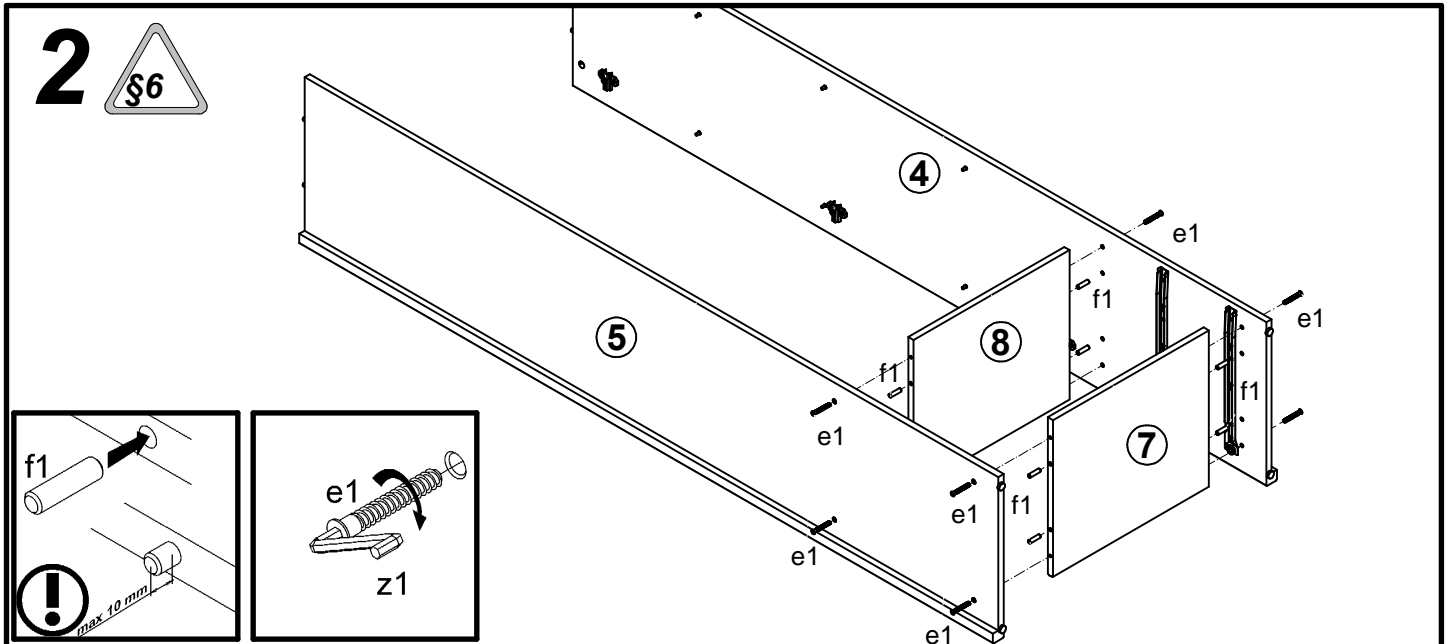
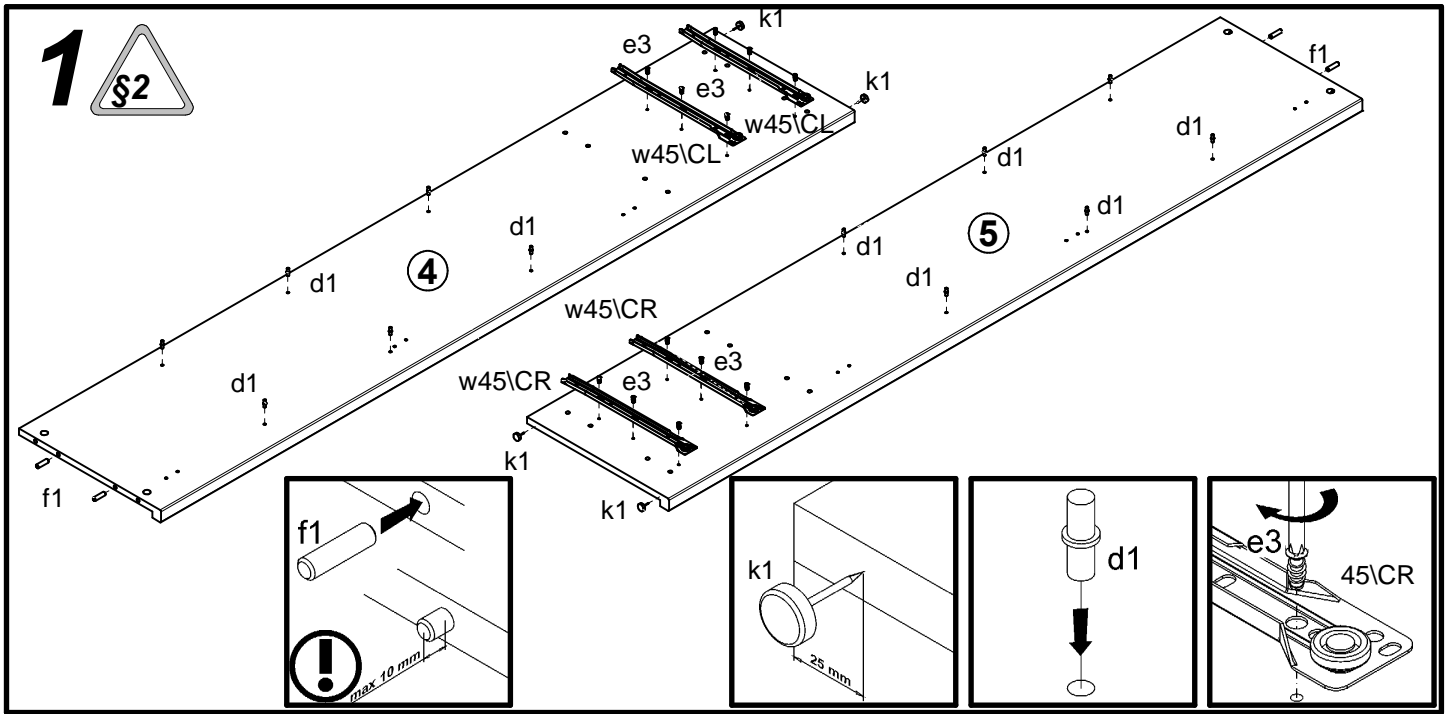

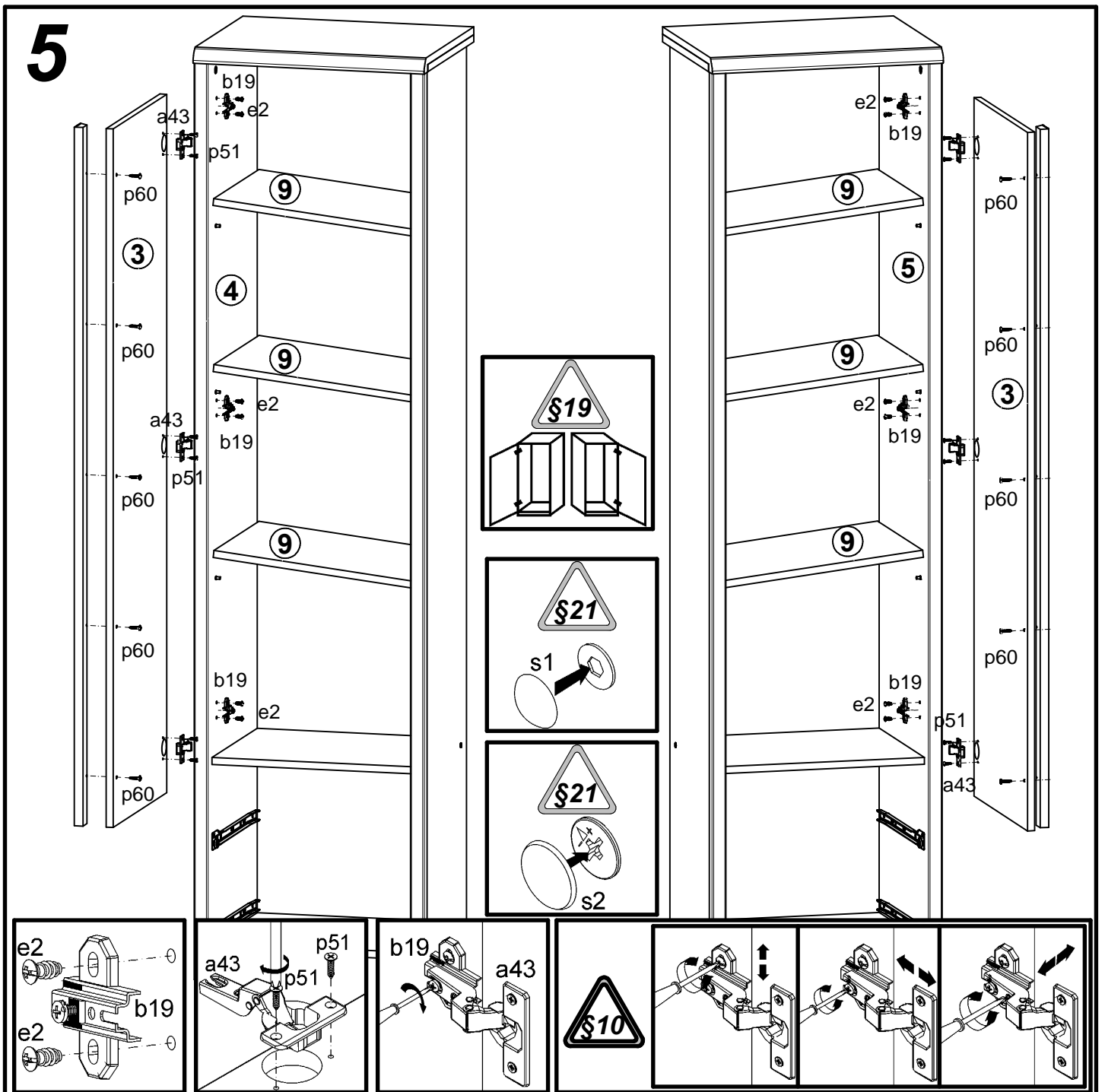
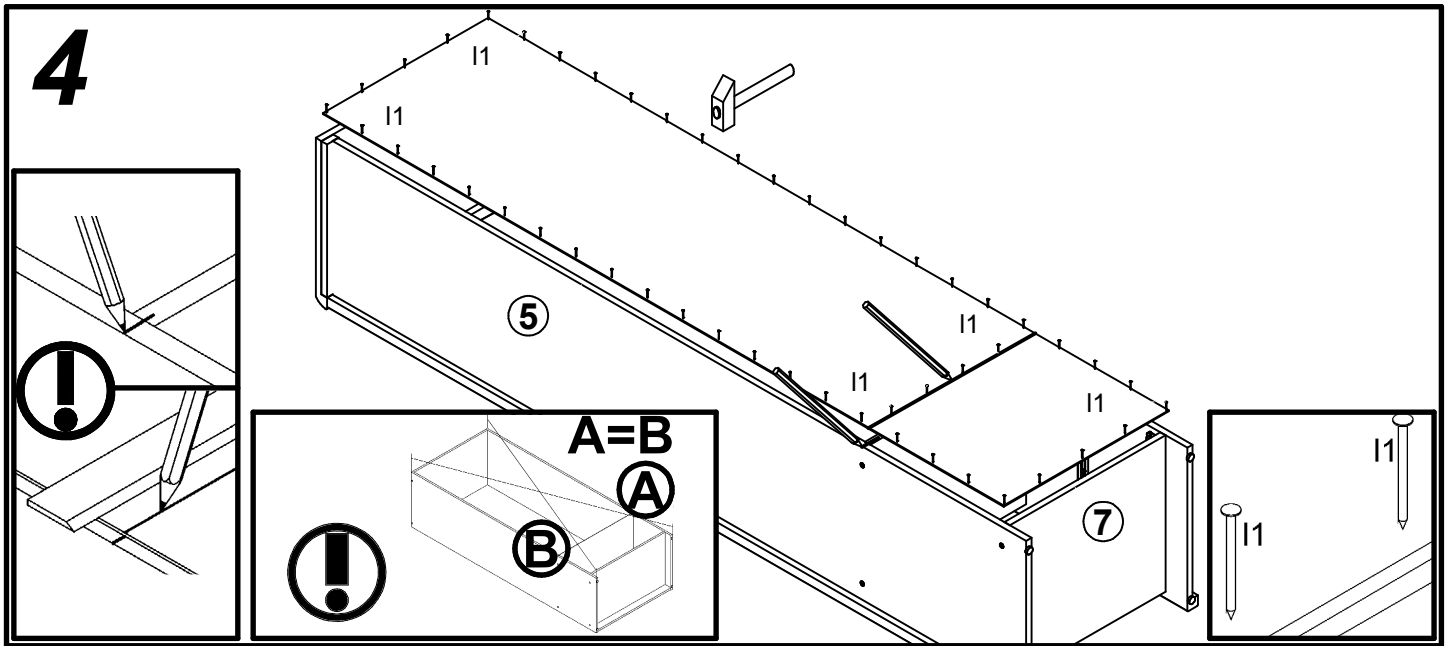

6

